

REHOBOT®

MADE IN SWEDEN

POWER WITH HYDRAULICS

INDUSTRIAL PRODUCTS

PRODUCT OVERVIEW



256 TON

HAND PUMPS, ELECTRICAL PUMPS, PETROL
DRIVEN PUMPS, AIR DRIVEN PUMPS,
CYLINDERS, HOLLOW SHAFT CYLINDERS,
COMPACT CYLINDERS, ACCESSORIES



ABOUT REHOBOT HYDRAULICS

REHOBOT Hydraulics is a successful Swedish company who specializes in: development, manufacturing and marketing of high quality, high pressure hydraulic products & systems, used in Service & Maintenance applications worldwide in ambient or harsh environments as the customers requirements demand.

REHOBOT through its acquisition of the NIKE trademarks in 2010 is able to enhance and improve on the reputation already in the market place for quality, reliability and performance. The product portfolio includes: Hydraulic pumps, Cylinders/Rams, Workshop equipment, Hydraulic tools and Rescue equipment.

Our business is divided into three main business areas:

- Industrial
- Automotive
- Rescue

REHOBOT operates from its Head office in Eskilstuna Sweden, which also incorporates its manufacturing and R&D facilities. To enhance the company's on-going development, we currently have fully operational subsidiaries in the: United Kingdom and USA. This base is also supported by an extensive network of authorized distributors, dealers & service centres.

WE SOLVE YOUR PROBLEMS

REHOBOT has extensive experience in developing and producing bespoke solutions designed to our customers needs based on the latest High Pressure Hydraulic technology.

With 90 years background experience, we can develop cost effective bespoke solutions to your requirements, to budget and on-time.

ALWAYS EXCEEDING YOUR EXPECTATIONS!

REHOBOT's reputation has been founded on quality of the products produced. Our goal now is to exceed your expectations, not only with the quality and reliability of the products, but also with a comprehensive customer orientated support & service structure.

REHOBOT Industrial Hydraulic Products are used in many different applications and users worldwide. Process, mining, steel, construction, railways and shipbuilding are some of the many industries we serve.

The equipment we have supplied to these customers includes:

Hand/Air/Electric powered hydraulic pumps, steel and aluminium cylinders, push-pull kits, pullers, spreaders, cutting tools, and specialized tools kits.

REHOBOT, works in close collaboration with many leading OEM Companies, which has resulted in the development of customised solutions, meeting the client's exact unique demands, ensuring a long and mutually profitable relationship.

REHOBOT Hydraulics is certified in accordance with ISO 9001 & ISO 14001 - standards.



REHOBOT's products are suitable for use in harsh environments.



Lifting capacity and stroke can be adjusted to match the application that the cylinders are used in.



Custom made pumps developed for the Automotive industry. Constantly challenged to improve automotive productivity.



PUMPS – CREATING POWER!

REHOBOT pumps have a functional design to withstand rough handling in harsh environments. They can be used in many different applications & industries. The pumps can be used with all hydraulic tools and cylinders in the REHOBOT's product range.

REHOBOT pumps are used worldwide and every possible environment. Some examples can be found within the engineering, automotive, mining and petrochemical industries.

We are happy to tailor the pumps to our customers' needs, thus providing flexible and cost effective solutions.

Our designs are based on long experience within the field of hydraulics. The results are pumps that are easy to operate, repair & service - saving time and money for our customers! The life expectancy of REHOBOT products leads the market. Our pumps provide power that last for generations!

Hand powered pumps – Are lightweight, portable and do not require an external power source. These pumps are cost effective, easy to use, and are ideal for workshop or field use applications.

REHOBOT PUMPS ARE

- Cost effective
- High quality
- Reliable
- Ergonomically designed
- Simple to use

Air powered pumps – A cost effective option for faster and more efficient operations. No manual effort required by the operator. Portable and ideal for workshop use, only standard air-line supply required. Field use is feasible if access to a compressor is available.

Electrically powered pumps– The best option where large capacities of oil is required: e.g. multiple cylinder operations. By the addition of different valve types, these pumps can easily operate multiple tools. The electric pumps are suitable in stationary installations.

Petrol powered pumps – An excellent alternative where, field operations are required: e.g. construction sites and shipyards. No external power source is required.

Should you be unable to find a pump to suit your requirement in the following series and table, please contact REHOBOT to discuss your application in detail.

REHOBOT'S DIFFERENT PUMP SERIES

- PH - series - Single stage hand pump
- PHS - series - Two stage hand pump
- PME - series - Electrically powered pump
- PMP - series - Petrol powered pump
- PP - series - Air powered pump

PH - SINGLE STAGE HAND PUMPS

The single stage PH series of hand pumps are available with 700 or 800 bar working pressure and with the option of 600 & 1000 cm³ useable oil reservoir capacities.

The 700 bar version can also be fully assembled with 2m long hose (LS201ES), swivel coupling (ASE10) & female half coupling AQI7 upon order. The order code for these variants are: PH70-600/LS201 & PH70-1000/LS201 respectively.

Technical tip: To ensure complete operator safety at all times we recommend the fitting of a pressure gauge (AMT801) with gauge adaptor (AVM204) to this series of hand pumps.



PRESSURE GAUGES

An example of a pump PH70-600 equipped with pressure gauge AMT801 & gauge adaptor AVM204, used for display of the hydraulic pressure.



SHUT-OFF VALVE

VAD22 shot off valve increase and improve the usage of the hand pump. Shut-off valves for hose- or direct assembly onto the pump is included in the range of accessories

Name	Part number	Working pressure MPa	Eff. oil volume cm ³	Capacity cm ³ /stroke	Pump force N	Length mm	Width mm	Height mm	Weight kg
PH70A-600	49100	70	600	2.9	450	590	90	170	4.5
PH70A-600/LS201	49108	70	600	2.9	450	590	90	170	4.7
PH70A-1000	49101	70	1000	2.9	450	590	110	170	5.2
PH70A-1000/LS201	49109	70	1000	2.9	450	590	110	170	5.4
PH80A-600	49102	80	600	2.9	515	590	90	170	4.5
PH80A-1000	49103	80	1000	2.9	515	590	110	170	5.2

Note: The hydraulic connection interface on all PH-pumps is constituted by a G1/4" threaded port.

Technical tip: When fitting hoses & accessories to any hydraulic equipment, please ensure that the working pressure rating matches or exceeds that of the pump supplying the system. Also ensure the effective oil volume of the pump exceeds the total oil volume of the hydraulic system.

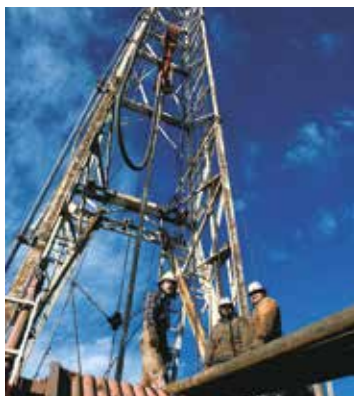

PHS - TWO STAGE HAND PUMPS

The REHOBOT two-stage PHS hand pump comes with a pressure gauge as standard. This gives the user a precise and safe control over the work carried out. The gauge is directly mounted onto the pump and well protected by the specially designed pump lever. The 2-stage function makes the pump simple to operate permitting the cylinder or hydraulic tool to reach its working position much faster compared with 1-stage pumps.



- Hydraulic return connection port standard on all pumps
- Robust aluminium tank with low weight and simple oil filling
- Needle hold/release valve - ensures precise control over lowering operation
- Mounting holes for fixed installations & handle locking system for easy carrying

The PHS-pumps with 70MPa pumps are also available fully assembled with hose including a quick coupling AQI7 and swivel coupling ASE10. Please contact REHOBOT to obtain further details and ordering information.

Name	Part number	Working pressure MPa	Eff. oil volume cm ³	Capacity cm ³ /stroke		Pump force N	Pressure gauge Type	Length mm	Width mm	Height mm	Weight kg
				High-pressure	Low-pressure						
PHS70-300	44411	70	300	1	20	350	AMT801	320	110	170	6
PHS70-300/LS201	44418	70	300	1	20	350	AMT801	320	110	170	6
PHS70-1000	44400	70	1000	2	20	320	AMT801	620	110	170	8.1
PHS70-1000/LS201	44414	70	1000	2	20	320	AMT801	620	110	170	8.5
PHS70-2400	44405	70	2400	2	20	320	AMT801	620	110	170	9.9
PHS70-2400/LS201	44413	70	2400	2	20	320	AMT801	620	110	170	10.4
PHS70-4100	50605	70	4100	2	20	320	AMT801	620	140	170	13.7
PHS80-300	44412	80	300	1	20	400	AMT801	320	110	170	6
PHS80-1000	44401	80	1000	2	20	360	AMT801	620	110	170	8.1
PHS80-2400	44406	80	2400	2	20	360	AMT801	620	110	170	9.9
PHS80-4100	50606	80	4100	2	20	360	AMT801	620	140	170	13.7
PHS100-1000	44402	100	1000	1	20	230	TX104	620	110	170	8.3
PHS100-2400	44407	100	2400	1	20	230	TX104	620	110	170	10.1
PHS150-1000	44403	150	1000	1	20	370	TX104	620	110	170	8.3
PHS150-2400	44408	150	2400	1	20	370	TX104	620	110	170	10.1
PHS150-1000L	44899	150	1000	1	20	370	AMT151	620	110	170	8.5
PHS150-2400L	44903	150	2400	1	20	370	AMT151	620	110	170	10.3

*) PHS240 are designed for ultra high pressures. All additional components & accessories needs to be selected for use with ultra high pressures e.g. equipped with a conical sealing principle. The hydraulic pressure port connection interface on the PHS240-2400L is a 9/16" - 18 UNF thread port with 60° Internal cone. The pressure return connection is constituted by a G1/4" internal threaded port.

Note: The hydraulic pressure & return connection interface on all other PHS-pumps are constituted by two G1/4" threaded ports. **Technical tip:** When fitting hoses & accessories to any hydraulic equipment, please ensure that the working pressure rating matches or exceeds that of the pump supplying the system. Also ensure the effective oil volume of the pump exceeds the total oil volume of the hydraulic system.



PRESSURE GAUGE

All pumps in the PHS-series comes with a pressure gauge as standard. Different units for the representation of pressure or load can be supplied upon request.



PRESSURE VALVES

PHS-pumps with the pressure range of 70-80 MPa can be equipped with a directional valves. These accessories enable operation of double acting cylinders or other hydraulic tools.



PME - ELECTRICALLY POWERED PUMPS

REHOBOT's electrically powered hydraulic pumps are reliable, versatile and easy to use. All pumps have a double-speed operation with automatic switching between high and low pressure at 2 MPa - 6 MPa depending on the pump type.

The low-pressure unit is a gear pump that gives a high flow up to the switching pressure. The high-pressure unit is a single or double-piston pump.

PME70-2030ADV and PME70-2030MRV are equipped with foot actuated pedal for on/off control. All other models have a start/stop button placed on the motor.

Description of the valve alternatives:

ADV - Automatic release valve. Oil returns to tank when motor is switched off. The pressure built up in the tool then drops and the tool returns automatically. For crimping, cutting or press tools that are used in high-frequency applications. Not for lifting applications!

MRV - Manual release valve. Suitable when you want to maintain the pressure in the tool for an extended period and have a controlled release. Recommended usage with tools for cable crimping or cutting.

AP - Adapter plate. This pump has no valve, but simply a connecting plate with G1/4" pressure & return ports.

MLS - With lever valve for single-acting tool/cylinder.

MLD - With lever valve for double-acting tool/cylinder.

SS - With solenoid valve for single-acting tool/cylinder (24 V DC). Remote control TRC230-24 or external input control is needed.

SD - With solenoid valve for double-acting tool/cylinder (24 V DC). Remote control TRC230-24 or external input control is needed.

Name	Part number	Working pressure MPa	Eff. oil volume cm ³	Capacity cm ³ /min		Motor V/kW	Length mm	Width mm	Height mm	Weight kg
				Low pressure	High pressure					
PME70-2030ADV	43005	70	3200	2700	300	230/0.55	285	285	520	23
PME70-2030MRV	43006	70	3200	2700	300	230/0.55	335	285	520	23
PME70-2030AP	43000	70	3200	2700	300	230/0.55	285	285	520	23
PME70-2030MLS	43001	70	3200	2700	300	230/0.55	330	285	520	24
PME70-2030MLD	43002	70	3200	2700	300	230/0.55	330	285	520	24
PME70-2030SS	43003	70	3200	2700	300	230/0.55	380	300	520	27
PME70-2030SD	43004	70	3200	2700	300	230/0.55	380	300	520	27
PME70A-4100AP	43007	70	10000	7500	1600	400/2.2	335	370	575	45
PME70A-4100MLS	43008	70	10000	7500	1600	400/2.2	375	370	575	46
PME70A-4100MLD	43009	70	10000	7500	1600	400/2.2	375	370	575	46
PME70A-4100SS	43010	70	10000	7500	1600	400/2.2	430	370	575	49
PME70A-4100SD	43011	70	10000	7500	1600	400/2.2	430	370	575	49
PME70A-4200AP	43012	70	20000	7500	1600	400/2.2	460	525	525	62
PME70A-4200MLS	43013	70	20000	7500	1600	400/2.2	480	525	525	63
PME70A-4200MLD	43014	70	20000	7500	1600	400/2.2	480	525	525	63
PME70A-4200SS	43015	70	20000	7500	1600	400/2.2	460	525	525	66
PME70A-4200SD	43016	70	20000	7500	1600	400/2.2	460	525	525	66

Note: The hydraulic pressure & return connection interface on all PME-pumps are constituted by two G1/4" threaded ports.

Technical tip! To ensure complete operator safety at all times we recommend the fitting of a pressure gauge (AMT801) with gauge adaptor (AAM14) to this series of pumps

PPxx-1000 - AIR HYDRAULIC PUMPS

PPxx-1000 air hydraulic pumps are compact pumps that operate in any position, horizontally or vertically. The pumps can easily be operated by hand or foot.

- High oil flow.
- Easy to fill & check oil level.
- Over pressure safety valve prevents overfilling of the tank during release operation which minimizes risk of injury!
- Return oil hose can easily be connected to oil reservoir filler hole.



Technical tip! For PPxx - pump series we recommend pressure gauge AMT801 & gauge adaptor AVM204.

PP70-1000 - the pumps can be supplied with pre-mounted hose 2 m or 2,5 m, quick coupling (AQI7) and swivel coupling (ASE10). The product designation in such cases are PP70-1000/LS201 (2m) with part nr: 45193 or PP70-1000/LS250 (2,5m) with part nr: 45192

Name	Part number	Working pressure MPa	Eff. oil volume cm ³	Capacity cm ³ /min		Air pressure MPa		Length mm	Width mm	Height mm	Weight kg
				Low-pressure	High-pressure	min	max				
PP70B-1000	49300	70	1000	750	170	0.6	1.2	439	100	174	5.9
PP80B-1000	49301	80	1000	600	160	0.6	1.2	439	100	174	5.9
PP100B-1000	49302	100	1000	600	120	0.6	1.2	439	100	174	5.9
PP150B-1000	47685	150	1000	369	65	0.6	1.2	439	100	174	5.9

Note: The hydraulic connection interface on all PP - pumps is constituted by a G1/4" threaded port.

PPxx-9200 - AIR HYDRAULIC PUMPS

PPxx-9200 series pumps are delivered with remote control. Pump is controlled by two buttons on the control unit (start/stop and release).

- Large tank capacity (9.2 liter).
- 2.5 m remote lead & handle controls.
- Operating air pressure 6 to 10 bar
- Separate pressure gauge connection.
- Can easily be equipped with manifold blocks and valves ideal for multi cylinder operations.
- Internal safety relief valve for overload protection



Name	Part number	Working pressure MPa	Eff. oil volume cm ³	Capacity cm ³ /min		Air pressure Bar		Length mm	Width mm	Height mm	Weight kg
				Low-pressure	High-pressure	min	max				
PP70-9200RC	50010	70	9200	1070	200	6	10	426	296	245	20
PP80-9200RC	50011	80	9200	710	150	6	10	426	296	245	20

Note: The hydraulic pressure connection interface on all PP-pumps is constituted by a G1/4" threaded port.

PPxx-2500 - AIR HYDRAULIC PUMPS



The PPxx-2500 series incorporates the following features:

- FP, RC and MRV models have built-in release valve that return oil to the tank.
- Safe, internal overflow & integrated safety valve.
- High oil-flow, sight level glass & robust aluminium design

Designed to be powered by 2.5 to 10 Bar air pressure line the PPxx-2500 ensures a trouble free and ergonomic way of generating hydraulic pressure. The air driven pump is suitable for stationary use in workshops and many other industrial applications.

The PPxx-2500 is ideally suited for use with REHOBOT Push & Pull kits and other hydraulic tools or cylinders. The pump can easily be equipped with additional pressure gauges, preassemble with hoses or couplings and comes with a vast number of valve options.

VALVE OPTIONS

Name	Description
FP	Foot Pedal. The FP option is ideal when both hands of the operator needs to be working with the work piece or tool. The foot pedal control the start/stop of hydraulic flow and also its release back to the oil reservoir.
RC	Remote Control. The RC option with a remote control is utilized by a 2.5 m remote control unit. The pump is controlled by two push buttons on the remote unit controlling the start/stop of hydraulic flow and its release back to the oil reservoir.
MLD	Manual Lever control for Double acting tools. The manual lever is set to direct the hydraulic flow over 2 different ports. A foot pedal is used for the start/stop function.
MRV	Manual Release Valve. The MRV option is suitable when the pump is used together with tools equipped with internal valve functions. The pumps has a G1/4" pressure & return connection and a manual release valve.

Name	Part number	Working pressure MPa	Eff. oil volyme cm ³	Capacity cm ³ /min		Air pressure MPa min	Length mm	Width mm	Height mm	Weight kg
				Low-pressure	High-pressure					
PP70-2500FP	50000	70/700	2500	1150	260	0.65/6.5	355	209	187	10.1
PP70-2500RC	50001	70/700	2500	1070	200	0.65/6.5	355	209	175	10.8
PP70-2500MLD	50002	70/700	2500	1150	260	0.65/6.5	355	209	214	10.5
PP70-2500MRV	50003	70/700	2500	1150	260	0.65/6.5	355	209	171	9.8
PP80-2500FP	50004	80/800	2500	760	170	0.6/6	355	209	187	10.1
PP80-2500RC	50005	80/800	2500	710	130	0.6/6	355	209	175	10.8
PP80-2500MLD	50006	80/800	2500	760	170	0.6/6	355	209	214	10.5
PP80-2500MRV	50007	80/800	2500	760	170	0.6/6	355	209	171	9.8
PP100-2500FP	50008	100/1000	2500	760	100	0.65/6.5	355	209	187	10.8
PP100-2500RC	50009	100/1000	2500	710	80	0.65/6.5	355	209	175	11.5

Note: The hydraulic connection interface on all PP - pumps is constituted by a G1/4" threaded port.

Air inlet interface on the RC & MRV versions are constituted by a G1/4" port.

Air inlet interface on the FP & MLD versions are constituted by a NPT1/4" port.

All pumps can be equipped with a pressure gauge. For pumps with valve option RC/MLD/MRV we recommend pressure gauge AMT801. For pumps with valve option FP we recommend pressure gauge AMT801 and gauge adaptor ATM214.

All PPxx-2500 series pumps are available in a pre-mounted version with hydraulic hose, Quick coupling AQ17 and Swivel coupling ASE10. Please contact you local REHOBOT representative to obtain the correct part number for PPxx-2500 equipped with these options.



CYLINDERS – PERFORMANCE IN A LIMITED SPACE!

REHOBOT cylinders are designed to withstand rough handling in harsh environments. Their use are highly varied. The cylinders can be used wherever there is something which needs to be pulled, pushed or lifted.

REHOBOT's cylinders are used worldwide and in all possible environments. Some examples can be found within the engineering, automotive, mining and petrochemical industries.

The standard range of products is rich with cylinders of different strokes and capacity. We also provide a wide range of accessories extending the use of the cylinders.

We are happy to tailor the cylinders to our customers' needs. Something that enables flexible and cost effective solutions with virtually unlimited lifting capacity. The cylinders are an effective tool for all use ranging from small precision work to lifting of 500-ton bridge sections.

Our designs are based on more than 70 years of experience within the field of hydraulics. The results are cylinders which are easy to repair and service - saving

time and money, thus providing a low total cost of ownership for the user. The pistons on our cylinders are hard chromed, making them resistant to wear and free of rust. The quality and performance of REHOBOT's products ensure long term tangible benefits. - Our cylinders simply last for generations!

The choice of the cylinder is normally selected by the working operation, pressure range, stroke and boundary dimensions of the cylinder. Considerations when selecting the cylinder for a specific application should also be given to the available range various accessories like extension tubes, pressure heads etc. All to make the most out of the hydraulic solution.

When an existing hydraulic equipment is available, the selection of cylinder preferably become based on the existing equipment's pressure range. All to deliver the greatest flexibility and overall economy.

REHOBOT - CYLINDERS FEATURES

- Hard chromed pistons, making them resistant to wear and free of rust.
- Galvanized cylinders for increased corrosion resistance.
- Mechanical stoppage of the piston movement.

QUICK COUPLING ON ALL CYLINDERS

- An AQU8 (male) quick coupling is normally mounted on all cylinders on delivery.
- AQI24 quick coupling (female) can be equipped during manufacturing. In such cases shall a "P" be added to the product designation, e.g. CF104P.

CF/CFU - SINGLE ACTING PUSH CYLINDER WITH SPRING RETURN

CF cylinders are workhorses in REHOBOT's cylinder range. They can be used for a variety of purposes. The cylinders are prepared for accessories to be connected at the piston top or at the bottom of the cylinder. The CF - cylinders can easily be mounted in applications by the use of its collar mounting threads.

- High strength alloy steel design for multi purpose use.
- 5 to 25 ton capacity with 127mm - 300 stroke length.
- Removable grooved piston cap & chromated piston rods.

CFU - series have an extended piston pin in order to be used for instance for clevis fitting etc.



Name	Part number	Pressure MPa	Capacity kN (t)	Stroke mm	Stroke volume cm ³	Piston rod ø mm	Piston area cm ²	Diameter mm	Height mm	Weight kg
CF104	27485	70	49 (5)	127	90	26.5	7.1	37.5	266	1.7
CF204	27486	70	49 (5)	200	142	26.5	7.1	37.5	339	2.4
CF110	43829	70	111 (11)	150	239	38	15.9	56.5	321	4.7
CF210	43830	70	111 (11)	200	318	38	15.9	56.5	372	5.5
CF310	43831	70	111 (11)	300	477	38	15.9	56.5	474	7
CF120	24178	70	232 (24)	127	422	60	33.2	84	337	10.2
CF220	24973	70	232 (24)	200	664	60	33.2	84	410	12.4
CF320	24974	70	232 (24)	300	996	60	33.2	84	510	16
CFU2010	43837	70	111 (11)	200	318	38	15.9	56.5	387	5.3
CFU2510	43838	70	111 (11)	250	398	38	15.9	56.5	437	6

CFA - ALUMINIUM PUSH CYLINDERS WITH SPRING RETURN

REHOBOT push cylinders in the CFA series have a capacity between 23 & 50 ton. The aluminium material provides superior performance in the relation between capacity and weight (about 50% more power per kilo compared with similar cylinders made of steel). The cylinders are manufactured out of high strength aluminium which gives it a much longer life compared with similar products on the market.

- 23 to 100 ton capacity.
- 100mm to 200mm stroke length.
- Anodised cylinder & piston for increased wear & corrosion protection.

CFA cylinders are delivered with a top lip and a protective bottom plate of steel. All to warrant proper function even if the base and lifting points are rough.

NOTE! These cylinders are designed for general service and maintenance applications. Should your application require high cycle repetitive use, please contact REHOBOT to discuss your application.



Name	Part number	Pressure MPa	Capacity kN (t)	Stroke mm	Stroke volume cm ³	Piston ø mm	Piston area cm ²	Diameter mm	Height mm	Weight kg
CFA250-100	48978	70	232 (24)	100	332	60	33.2	100	212	4.4
CFA250-200	48980	70	232 (24)	200	664	60	33.2	100	312	5.9
CFA500-100	47153	70	496 (51)	100	709	85	70.9	140	224	9.2
CFA500-200	47160	70	496 (51)	200	1418	85	70.9	140	324	12.7
CFA750-100	47185	70	727 (74)	100	1039	100	103.9	170	235.5	14
CFA750-200	47186	70	727 (74)	200	2078	100	103.9	170	335.5	18.3
CFA1000-100	47163	70	929 (95)	100	1327	110	132.7	190	243	18.4
CFA1000-200	47171	70	929 (95)	200	2655	110	132.7	190	343	24.7

CFC - COMPACT SINGLE ACTING, PUSH CYLINDERS WITH SPRING RETURN

CFC cylinders are real all-round cylinders. The design allows small dimensions and built in measurements. The cylinders are fitted with scrapers to keep the piston clean from dirt, always ensuring proper function in harsh environments.

- Wiper polyurethane, positioned so that dirt can not penetrate between the piston rod and cylinder
- Corrosion protection - plated piston rod and electroplated cylinder
- Collar mounting threads as standard.
- Optional base mounting holes at the bottom of the cylinder.



CFC cylinders are available in capacities between 5 to 100 tons. Models with 5 t, 10 t, 15 t and 25 tons capacity can be fitted with adapters for mounting of accessories such as pressure heads or chains, extending the use of the cylinder.

Name	Part number	Pressure MPa	Capacity kN (t)	Stroke mm	Stroke volume cm ³	Piston ø mm	Piston area cm ²	Diameter mm	Height mm	Weight kg
CFC51	40184	70	49 (5)	27	19	25	7	38	110	0.8
CFC53	40186	70	49 (5)	77	55	25	7	38	165	1.2
CFC55	40188	70	49 (5)	127	90	25	7	38	216	1.5
CFC57	40190	70	49 (5)	181	128	25	7	38	273	1.9
CFC59	40192	70	49 (5)	232	165	25	7	38	324	2.2
CFC101	40235	70	111 (11)	25	40	38	16	57	90	1.5
CFC102	40237	70	111 (11)	54	86	38	16	57	121	2
CFC104	40239	70	111 (11)	105	167	38	16	57	171	2.7
CFC106	39849	70	111 (11)	155	247	38	16	57	247	4
CFC108	39850	70	111 (11)	206	328	38	16	57	298	4.6
CFC1010	39851	70	111 (11)	257	409	38	16	57	349	5.3
CFC1012	39852	70	111 (11)	305	485	38	16	57	400	6
CFC1014	39853	70	111 (11)	356	566	38	16	57	451	6.8
CFC151	40264	70	166 (17)	25	59	48	24	70	124	3
CFC152	40266	70	166 (17)	51	121	48	24	70	149	3.5
CFC154	40268	70	166 (17)	101	240	48	24	70	200	4.5
CFC156	39881	70	166 (17)	152	361	48	24	70	272	6.5
CFC158	39882	70	166 (17)	203	482	48	24	70	322	7.5
CFC1510	39883	70	166 (17)	254	603	48	24	70	373	8.5
CFC1512	39884	70	166 (17)	305	725	48	24	70	424	9.5
CFC1514	39885	70	166 (17)	356	846	48	24	70	475	10.9
CFC251	39940	70	232 (24)	25	83	60	33	85	140	5.1
CFC252	39941	70	232 (24)	51	169	60	33	85	165	5.9
CFC254	39942	70	232 (24)	101	335	60	33	85	216	7.7
CFC256	39943	70	232 (24)	159	528	60	33	85	273	9.7
CFC258	39944	70	232 (24)	209	694	60	33	85	324	11.5
CFC2510	39945	70	232 (24)	260	863	60	33	85	375	13.3
CFC2512	39946	70	232 (24)	311	1032	60	33	85	426	15
CFC2514	39947	70	232 (24)	362	1201	60	33	85	476	17
CFC502	40292	70	496 (51)	53	376	80	71	127	176	16
CFC504	40294	70	496 (51)	104	737	80	71	127	227	19
CFC506	40296	70	496 (51)	159	1127	80	71	127	282	23
CFC5013	40298	70	496 (51)	337	2389	80	71	127	460	35
CFC756	40344	70	727 (74)	155	1610	100	104	146	282	30
CFC7513	40345	70	727 (74)	333	3459	100	104	146	492	48
CFC1006	40388	70	929 (95)	168	2230	100	133	175	359	54
CFC10010	40389	70	929 (95)	260	3451	100	133	175	450	65



CL - LOW PUSH CYLINDERS, GRAVITY RETURN

- Compact design for limited space applications.
- Prepared with mounting holes at bottom for fastening.
- Replaceable reinforced pressure cap.

CL-cylinders are ideal for those who need a compact installation dimensions. Holes in cylinder bottom makes them easy to integrate into the application.

Name	Part number	Pressure MPa	Capacity kN (t)	Stroke mm	Stroke volume cm ³	Piston ø mm	Piston area cm ²	Diameter mm	Height mm	Weight kg
CL50-25	35680	70	49 (5)	25	18	26	7.1	39	60	0.7

CLF - LOW PUSH CYLINDERS WITH SPRING RETURN

CLF cylinders are the right choice for those who need flexible cylinders with small dimensions. With capacities ranging from 5 tons to 200 tons makes them suitable for lifting and other for purposes. Threaded mounting holes make them easy to integrate into various applications.

The CLF series are REHOBOT's smallest cylinder series - CLF50-10 reach an height of only 37 mm, but with an incredible 5-ton lifting capacity. Cylinders CLF670-45 and CLF1100-40 are equipped with a removable handles to facilitate their handling.



Name	Part Number	Pressure MPa	Capacity kN (t)	Stroke mm	Stroke volume cm ³	Piston ø mm	Piston area cm ²	Diameter mm	Height mm	Weight kg
CLF50-10	35132	70	50 (5)	10	7.1	24	7.1	60	37	0.6
CLF110-10	35133	70	111 (11)	10	15.9	35	15.9	80	43	1.5
CLF110-30	47067	70	111 (11)	28	44.5	35	15.9	65	75	1.8
CLF220-13	35320	70	218 (22)	13.5	42.1	50	31.2	100	50	2.6
CLF220-50	37553	70	218 (22)	50	156	50	31.2	85	107	3.9
CLF220-25	50450	70	218 (22)	25	78	50	31.2	96	65	3.25
CLF450-15	35305	70	445 (45)	15	95.4	60	63.6	134	68	6.4
CLF450-40	47071	70	445 (45)	40	254.4	60	63.6	120	120	8.8
CLF670-15	35413	70	665 (68)	15	142.5	80	95	146	78	9.2
CLF670-45	47075	70	665 (68)	45	427.5	80	95	146	130	14.3
CLF1100-15	35166	70	1078 (110)	15	231	100	154	180	90	17
CLF1100-40	47079	70	1078 (110)	40	616	100	154	180	140	23.7
CLF1500-15	35485	70	1498 (153)	15	321	125	214	220	100	28
CLF2000-16	35490	70	1985 (202)	16	454	140	284	250	110	40



HYDRAULIC HOSES

Our original hose is a black polyamide / polyurethane hose with steel reinforcement. The surface provides good abrasion resistance and long life.

See accessories catalogue for more information on the hoses and other accessories.



QUICK COUPLINGS

Swivel couplings can be installed on either pump, cylinders or on the hydraulic tools.

When using the swivel a variable/rotating (360 °) coupling between the pump and hose is achieved.

CPF - PULL CYLINDERS

CPF cylinders are pulling cylinders of 5 tons or 11 tons capacity. They are part of REHOBOT push and pull kits having threads on the piston top and cylinder bottom for attachment of accessories.

- Piston and cylinder case have threads as standard for fitting of accessories or mounting.

CPF cylinders are used, for example when reshaping welded structures.



Name	Part number	Pressure MPa	Capacity kN (t)	Stroke mm	Stroke volume cm ³	Piston ø mm	Piston area cm ²	Diameter mm	Height mm	Weight kg
CPF705	27300	70	45 (5)	125	80	20	6	48	412	2.4
CPF709	27280	70	110 (11)	127	199	32	16	70	436	5.9

CSF - STAINLESS STEEL SINGLE ACTING PUSH CYLINDERS WITH SPRING RETURN

- CSF-cylinders are available with 11 ton (13*) to 88 (100*) tons capacity and with 50 to 200 mm stroke length.
- Designed to compensate oblique loads better than conventional cylinders.
- Manufactured in stainless steel with hard chromatid piston.
- Collar mounting threads as standard.

All CSF - cylinders are equipped with spring return, wiper and quick coupling. Model CSF350 has also a carrying handle mounted on the cylinder frame.

*CSF-series are approved for working pressures up to 80 MPa (800 bar).



Name	Part number	Pressure MPa	Capacity kN (t) at 70MPa	Capacity kN (t) at 80MPa	Stroke mm	Stroke vol. cm ³	Piston ø mm	Piston area cm ²	Diameter mm	Height mm	Weight kg
CSF110-50	45092	80	111 (11)	127 (13)	50	80	45	15,9	58	134	2,3
CSF110-100	45094	80	111 (11)	127 (13)	100	159	45	15,9	58	184	3,0
CSF110-150	45096	80	111 (11)	127 (13)	150	238	45	15,9	58	234	3,7
CSF220-25	45098	80	218 (22)	249 (25)	25	78	63	31,2	80	115	3,7
CSF220-50	45100	80	218 (22)	249 (25)	50	156	63	31,2	80	140	4,4
CSF220-100	45102	80	218 (22)	249 (25)	100	312	63	31,2	80	190	5,9
CSF220-150	45104	80	218 (22)	249 (25)	150	467	63	31,2	80	240	7,3
CSF220-200	45106	80	218 (22)	249 (25)	200	623	63	31,2	80	290	8,7
CSF350-50	45108	80	352 (36)	402 (41)	50	241	80	50,2	105	146	8,5
CSF350-100	45110	80	352 (36)	402 (41)	100	502	80	50,2	105	196	11,0
CSF350-200	45112	80	352 (36)	402 (41)	200	1005	80	50,2	105	296	15,6
CSF550-50	45114	80	550 (56)	628 (64)	50	393	100	78,5	130	160	14,0
CSF550-100	45116	80	550 (56)	628 (64)	100	785	100	78,5	130	210	17,7
CSF550-200	45118	80	550 (56)	628 (64)	200	1570	100	78,5	130	310	24,9
CSF860-50	45120	80	859 (88)	982 (100)	50	613	125	122,6	160	183	23,7
CSF860-100	45122	80	859 (88)	982 (100)	100	1227	125	122,6	160	233	28,9
CSF860-200	45124	80	859 (88)	982 (100)	200	2453	125	122,6	160	333	39,3



CH/CHF - SINGLE ACTING STEEL HOLLOW BORE CYLINDERS

CH / CHF hollow cylinders can via the through-hole be used for both push or pull operations. For example, by inserting a rod through the cylinder, the compression force permit the cylinder to be used for pulling operations.

CH / CHF cylinders have a capacity of 6 tons to 51 tons and is very compact in its exterior dimensions. This makes them suitable for integration into applications.

CH62 has a gravity return & CHF62 cylinder has a spring return function.

Name	Part number	Pressure MPa	Capacity kN (t)	Stroke mm	Hollow diameter mm	Stroke volume cm ³	Piston ø mm	Piston area cm ²	Diameter mm	Height mm	Weight kg
CH62	42503	70	61 (6)	51	17	44.7	30	8.8	55	110	1.6
CHF62	45244	70	61 (6)	51	17	44.7	30	8.8	55	136	2

CHFA - SINGLE ACTING ALUMINIUM HOLLOW BORE CYLINDERS

CHFA series consists of cylinders made of aluminium. This makes the products up to 50% lighter than comparable models made out of steel. Due to its construction, hollow cylinders can be used for both push and pull operations. For example, by inserting a rod through the cylinder, the compression force also be used for pulling operations.

CHFA cylinders are available with capacities between 13 ton to 103 ton and stroke lengths up to 153 mm.

NOTE! These cylinders are designed for general service and maintenance applications. Should your application require high cycle repetitive use, please contact REHOBOT to discuss your application.



Name	Part number	Pressure MPa	Capacity kN (t)	Stroke mm	Hollow diameter mm	Stroke volume cm ³	Piston ø mm	Piston area cm ²	Diameter mm	Height mm	Weight kg
CHFA132	45862	70	123 (13)	52	22	92	40	17.6	80	165	2.3
CHFA136	46602	70	123 (13)	153	22	270	40	17.6	80	310	4
CHFA182	46621	70	176 (18)	51	26	128	45	25.1	94	171	3
CHFA184	46622	70	176 (18)	102	26	256	45	25.1	94	246	4
CHFA262	46641	70	255 (26)	51	32	186	60	36.4	115	180	4.9
CHFA266	46642	70	255 (26)	153	32	557	60	36.4	115	323	8.7
CHFA372	46661	70	358 (36)	51	39	261	70	51.2	136	189	6.9
CHFA376	46662	70	358 (36)	153	39	784	70	51.2	136	327	12
CHFA504	47733	70	508 (52)	104	51	756	80	72.7	160	276	14.7
CHFA673	46681	70	659 (67)	77	54	726	100	94.2	185	250	18
CHFA676	46682	70	659 (67)	153	54	1442	100	94.2	185	350	25
CHFA1003	46701	70	1010 (103)	77	66	1111	120	144.3	227	284	29
CHFA1006	46702	70	1010 (103)	153	66	2208	120	144.3	227	391	40

LS & LSS - HYDRAULIC HOSES

High Pressure Hose (2800 - 6250 bar burst pressure) - is a polyamide / polyurethane hose with steel reinforcement. Polyurethane provides good abrasion resistance and a lifetime exceeding other standard rubber hoses on the market. The hoses are delivered with with 2 seals (part no. 17009).

NOTE! We recommend that you always dimension by 3-4 fold margin of safety between the hydraulic systems maximum working pressure and burst pressure of the hose.



High pressure hoses (2800 - 6250 bar burst pressure)

Name	Length mm	ø Inner/Outer mm	Connection thread	Working pressure MPa/bar	Burst pressure MPa/bar	
LS51ES	500	6,3/13,5	G1/4"			
LS101ES	1000	6,3/13,5	G1/4"			
LS151ES	1500	6,3/13,5	G1/4"			
LS201ES	2000	6,3/13,5	G1/4"			
LS251ES	2500	6,3/13,5	G1/4"	70/700	280/2800	
LS301ES	3000	6,3/13,5	G1/4"			
LS401ES	4000	6,3/13,5	G1/4"			
LS501ES	5000	6,3/13,5	G1/4"			
LS1001ES	10000	6,3/13,5	G1/4"			
LSS103EB	1000	4,7/11,5	G1/4" ¹⁾			
LSS203EB	2000	4,7/11,5	G1/4" ¹⁾	150/1500	450/4500	
LSS303EB	3000	4,7/11,5	G1/4" ¹⁾			
LS204ER	2000	4,7/13	9/16" UNF ²⁾	240/2400	625/6250	
LS304ER	3000	4,7/13	9/16" UNF ²⁾			

1) One side equipped with a swivel connection.

2) Delivered with 9/16" UNF internal thread and a 60° external sealing cone.

Highly flexible hydraulic hoses

This is a black rubber hose reinforced with two layers of braided steel reinforcement. The hose is well-suited for flexible installations. The hose are delivered with two seals.

Name	Length mm	ø Inner/Outer mm	Connection thread	Work pressure MPa/bar	Burst pressure MPa/bar	
LS150ES	1500	6,3/15,5	G1/4"			
LS200ES	2000	6,3/15,3	G1/4"			
LS250ES	2500	6,3/15,5	G1/4"	70/700	160/1600	
LS350ES	3000	6,3/15,5	G1/4"			
LS500ES	5000	6,3/15,5	G1/4"			

ASE - SWIVEL COUPLINGS

Name	Connection thread	Max. working pressure
ASE10	G1/4"	80 MPa / 800 bar
ASE15	G1/4"	150 MPa / 1500 bar

Swivel couplings can be mounted to both cylinders, pumps or other hydraulic tools. By means of the swivel coupling you get an flexible connection between pump/tool and hose. This means more flexible operation of the tools, especially in combined spaces.

Swivel couplings can rotate 360° - even under pressure. ASE10 is delivered with one seal (17009).

ASE15 does not require additional sealing when mounted on a hydraulic unit with conical connection interface.

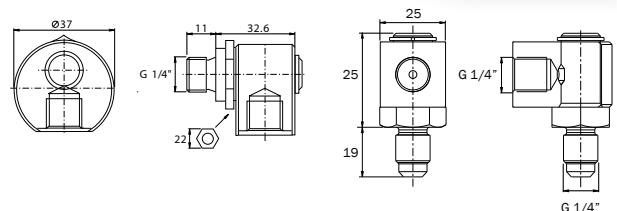

ASE10

ASE15

AQ - QUICK COUPLINGS

All quick couplings from REHOBOT have a check valve and are supplied with seals and protection caps made of metal or plastic.

- Insert and screw type couplings.
- Interchangeable with many other brands on the market.



Protection caps prevent contamination of the hydraulic system. Screw type couplings permit a higher flow rate than insert type couplings.

COUPLING & SUITABLE COUNTER COUPLINGS

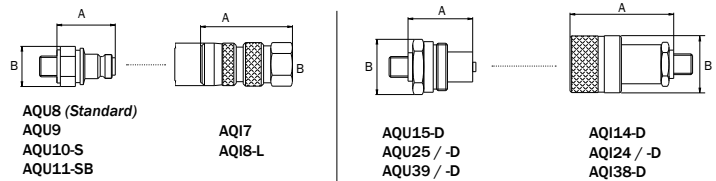

Name	Type	Male	Female	Max. pressure MPa/bar	Int. thread	Ext. thread	Locking ring	A mm	B mm	Flow l/min***	Dust protection		
												Standard	Alternative
AQI7	Insert		•	100/1000	G 1/4"	(1)		60	27	6	TDP26	-	
AQI8-L			•	100/1000	G 1/4"	(1)	•	60	27	6	TDM26	-	
AQU8			•	100/1000	(2)	G 1/4"		39	25	6	TDP23	TDM23	
AQU10-S*			•	100/1000	(2)	G 1/4"		40,5	25	6	TDP23	TDM23	
AQU11-SB**			•	100/1000	(2)	G 1/4"		40,5	25	6	TDP23	TDM23	
AQI14-D	Screw		•	100/1000		NPT 1/4"	•	48,5	30	15	TDM14	-	
AQU15-D			•	100/1000		NPT 1/4"		34	30	15	TDM15	-	
AQI24			•	100/1000	(3)	G 1/4"	•	72	36	35	TDP24	-	
AQI24-D			•	100/1000	(3)	G 1/4"	•	72	36	35	TDM24	-	
AQU25			•	100/1000	(3)	G 1/4"		52	35,5	35	TDP25	-	
AQU25-D			•	100/1000	(3)	G 1/4"		52	35,5	35	TDM25	-	
AQI38-D			•	100/1000		NPT 3/8"		•	68	36	35	TDM24	-
AQU39			•	100/1000		NPT 3/8"			39	35,5	35	TDP25	-
AQU39-D			•	100/1000		NPT 3/8"			39	35,5	35	TDM25	-

1) Addition of nipple AAU436 gives G1/4" external thread.
2) Removal of nipple AAU436 gives G1/4" internal thread.
3) Addition of nipple AA1456 gives G1/4" internal thread.

* Coupling AQU10-S has a built-in hose rupture valve.
** Coupling AQU11-SB has a built-in flow restriction/check valve.
*** Flow rate at 0,4 MPa(4 bar) pressure drop.

TDP = Plastic dust protection
TDM = Metal dust protection

AQ - QUICK COUPLINGS (ULTRA-HIGH PRESSURES)

Ultra high pressure systems puts high demands on the quality of the used components. We recommend that you always use REHOBOT approved accessories be selected when working with ultra high pressures.

- Quick couplings up to 250 MPa.

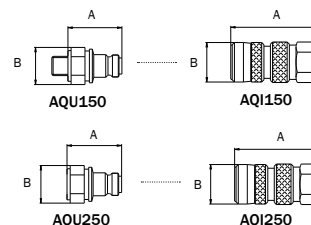

Name	Type	Male	Female	Max. pressure. MPa/bar	Int. thread	Ext. thread	A mm	B mm	Flow l/min**	Dust protection
AQI150	Insert		•	150/1500	G 1/4"*	(3)	60	27	6	Plastic
AQI250			•	250/2500	G 1/4"*	(2)	64	30	4,6	Plastic
AQU150			•	150/1500	(1)*	G 1/4"	62,5	25	6	Plastic
AQU250			•	250/2500	G 1/4"*	(2)	55,3	25	4,6	Plastic

1) Removal of nipple AAU436 gives G1/4" internal thread with 120° sealing cone.
2) Adapter is required: AAU241, AAU242 or AAU243
3) Addition of nipple AAU436 gives G1/4" external thread.
* Female thread with internal 120° sealing cone
** Flow rate is measured at 0,4 MPa(4 bar) pressure drop

AAE / TX - COUPLING NIPPLES

Coupling nipples from REHOBOT Hydraulics for hydraulic systems guarantee connectivity. The nipples can be used to adjust the thread dimensions of cylinders, hoses or ports.



Note! Please observe that seals are not included in (advise the table below to find the appropriate seal for your coupling nipple).

Name	Max. pressure MPa	A Ext. thread	B Ext. thread	C Int. thread	D Int. thread	Seal type (see below)
AAE478	80	G 1/4"	-	G 3/8"	-	A = 2 C = 3
AAE482		G 3/8"	-	G 1/4"	-	A = 3 C = 2
AAE487	100	G 1/2"	-	G 1/4"	-	A = 4 C = 2
AAE497		NPTF 3/8"-18	-	G 1/4"	-	A = - C = 2
AAE498		G 1/4"	-	NPTF 1/4"-18	-	A = 2 C = -
AAE499	80	G 1/4"	-	NPTF 3/8"-18	-	A = 2 C = -
AAE502	150	G 1/4"	-	G 1/4"	-	A = 2 C = 2
AAE504		G 1/4"	-	G 1/4"	-	A = 2 C = 2
AAE505*	80	G 1/4"	-	G 1/4"	-	A = 2 C = 2
AAI456		-	-	G 1/4"	G 1/4"	C = 2 D = 2
AAI457	-	-	-	G 1/4"	G 3/8"	C = 2 D = 3
AAU407	100	G 1/4"	G 3/8"	-	-	A = 2 B = 3
AAU408		G 1/4"	G 1/2"	-	-	A = 2 B = 4
AAU420		G 1/4"	NPTF 1/4"-18	-	-	A = 2 B = -
AAU421		G 1/4"	NPTF 3/8"-18	-	-	A = 2 B = -
AAU436	150	G 1/4"	-	-	-	A = 2
TX119	100	KR 3/8"	-	G 1/4"	-	A = - B = 2
TX120	80	G 1/8"	-	KR 3/8"	-	A = 1 B = -
TX121	100	G 1/8"	-	G 1/4"	-	A = 1 B = 2
TX122		G 1/4"	-	G 1/8"	-	A = 2 B = 1

*AAE505 - Coupling nipple with swiveling function (before tightening).

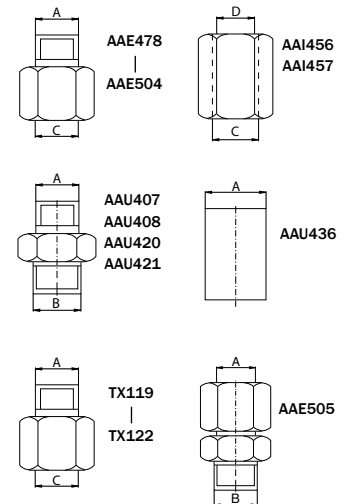

Accessories for 150 MPa systems

Hydraulic system operating at 1500 bar or more can be dangerous if the systems are not sealed properly.

Even if all components individually are approved for 1500 bar or more, there are other factors to consider.

Everything for the safe use of ultra high hydraulic systems.

Contact us for more information!

SEALS

Seal type	Part no	For thread
1	01044650	G ¹ / ₈ "
2	17009	G ¹ / ₄ "
3	16217	G ³ / ₈ "
4	14192	G ¹ / ₂ "

To ensure a proper sealing should the seal type be selected in accordance with the table above. This ensures a hydraulic system without leakage.

TY - HYDRAULIC OIL

Name	Volyme liter	Oil grade
TY41	1	ISO VG10
TY45	5	ISO VG10

Hydraulic oil of high quality guarantees excellent functionality of your hydraulic system.

Oil grade ISO VG10 or better should always be used with REHOBOT products.



AB / AF / ATI - MANIFOLD BLOCKS

If you look to build or develop sophisticated hydraulic systems, manifold blocks can be considered a vital component.

The manifold block is used to distribute the hydraulic flow over several individual ports in order to use the same pump for one or more hydraulic tools or cylinders.



Note: In order to plug any unused holes, use plug part number 16536 and seal with part number 17009. The seal is also used for sealing

Name	Max. pressure MPa/bar	Number of ports	A mm	B mm	C mm	D mm	E mm	F mm	G Int. thread	H Ext. thread	I	J
AB14	100/1000	2	45	30	22	20,5	12	21	G 1/4"	G 1/4"	-	-
AF55		6	100	30	40	30	40	10	G 1/4"	-	-	-
AF57		8	140	30	40	30	40	50	G 1/4"	-	-	-
ATI289		3	45	40	27	13	25	22,5	G 1/4"	-	-	-
ATU4*	150/1500	5	241	65	25	23	31	32,5	G 1/2"	G 1/4"	25	37
ATI3		3	85	25	60	12,5	-	-	G 1/4"	G 1/4"	-	-
ATI31		3	85	25	-	-	-	-	G 1/4"	G 1/4"	-	-
ATI32		3	70	25	29	15	25	-	G 1/4"	G 1/4"	-	-
AF41	300/3000	4							G 1/4"	-	-	-

*ATU4 - Additional G1/2" port for gauge assembly.

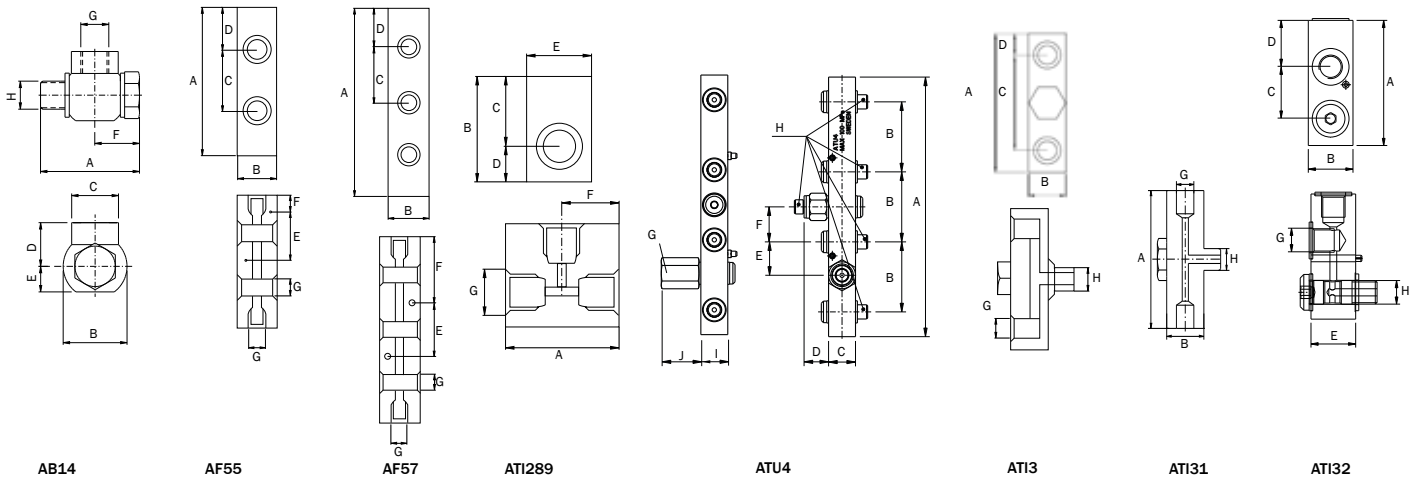

AB14

AF55

AF57

ATI289

ATU4

ATI3

ATI31

ATI32



DUAL LIFTING

Manifold blocks are a necessity for many advanced applications in high pressure hydraulics, such as the lifting of two or more cylinders.

With accessories from REHOBOT, you always get parts that fit your equipment at 100%.

MULTIPLE HYDRAULIC PORTS

Gauge adaptor AAM14 used for gauge type TX103 and TX104 can be mounted directly on the manifold blocks.

In order to plug any unused G1/4" hole, use plug part no. 16536 with seal part no. 17009.

The seal is also used for sealing between holes in manifold blocks and hoses.

VALVES OVERVIEW

REHOBOT offers many different type of valves. Ranging from shut-off valves, with regulating functions, directional valves and other valves for safety purposes.

Note! Seals are always included for valves with trough hollow screw i.e. VAD2 & VAT3.

Valve types without needs to be supplemented with seals.

For thread G 1/4" use part number 17009.



VA/ VAD / VAT - SHUT OF VALVES

Name	VA14	VAB114	VAD22	VAD2	VAT3
Max pressure MPa/bar	100/1000	80/800	80/800	80/800	80/800
Special function	-	Built in ball valve on/off function.	Built in gauge port	-	-
Mounting principle	Fixed mounting on hydraulic unit via G1/4"	Fixed mounting on hydraulic unit via G1/4"	Fixed mounting on hydraulic unit via G1/4"	For hose assembly	For hose assembly
Number of outlet ports	1	1	2 + Gauge port ⁽¹⁾	2	3

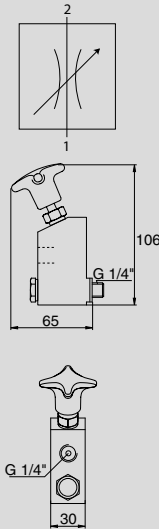
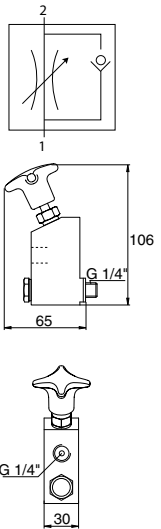
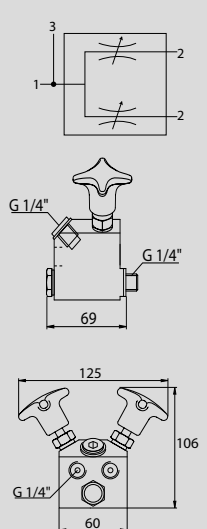
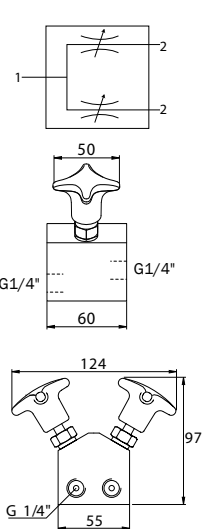
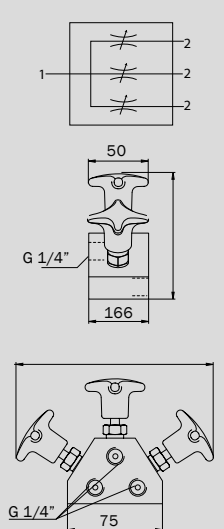
 VA14					
--	---	---	---	---	---

1) - Gauge adaptor AAM14 is required to fit additional pressure gauges!



SHUT-OFF VALVE

VAD22 mounted on a hydraulic pump model PP70-2500RC.

VAD22s shut-off valve increases the usability of the pump by dividing the hydraulic flow into two separate ports.



GAUGES & ADAPTOR

Pump PH70-600 equipped with a pressure gauge AMT801 & gauge adaptor AVM204, used for display of the hydraulic pressure.

Several different units on the gauges can be supplied by REHOBOT.

VR / VRH - DIRECTIONAL VALVES

VR / VRF - PRESSURE REGULATING VALVES

Name	VR42	VRH43
Max pressure MPa/bar	80/800	80/800
Hold function	-	Yes

Name	VR30	VRF31	VR150*
Max pressure MPa/bar	70/700	80/800	150/1500
Comment	Adjustable	Preset at 80 MPa	Adjustable ¹⁾

Note! Please observe that seals are not included. For thread G 1/4" we recommend seal with part number 17009.

Note! Please observe that seals are not included. For thread G 1/4" we recommend seal part number 17009 and for thread G 1/2" we recommend seal part no 14192.

** - Especially designed for hand pumps in the PHS-series.*

1) - Adjustable pressure between 50 - 150 MPa.

VS - SAFETY VALVE

Name	Preset pressure MPa	A Int. thread	B mm
VS14-90	90 - 95	G 1/4"	42
VS14-100	100 - 105	G 1/4"	42



A safety valve is a useful component for preventing excessive pressures in a hydraulic system. These valves are primarily designed for use on the return side of double acting hydraulic cylinders, and are preset at the factory for maximum pressure as shown in the table. The preset pressure must NOT be changed!

- Preset pressure at 95 or 105 MPa.
- Prevents your hydraulic system from pressure overload.

Note! If the preset pressure is exceeded then oil will leak out. You must therefore ensure that the user is protected against pressurised oil. Always install the safety valve in an enclosure or protected area.

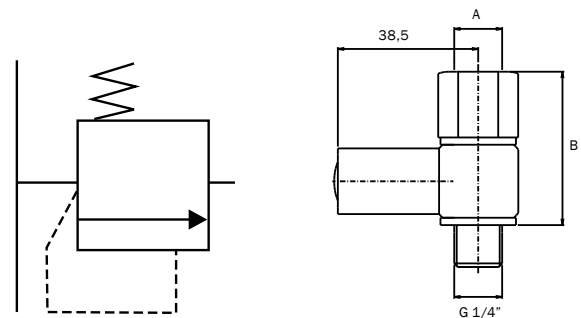

AMP / AMT / AMZ / TX - PRESSURE GAUGES

Gauges permit visual monitoring of the force and/or pressure generated by a hydraulic pump. This helps prevent accidental overloading and contributes to prolonging the life of your hydraulic equipment.

AMT801 and TX104 are fluid-damped gauge models which are recommended if there is a risk of pressure surges. Gauges with customised scales can be supplied on request.

Note! REHOBOT may provide calibrated pressure gauges upon request. Please contact you REHOBOT distributor prior to ordering such gauges.



Name	Number of scales	Measurement range	Scale division	Piston diameter mm	Piston area cm ²	A mm	B mm	C mm	D mm	E mm
AMP651	5	-40 kN	2 kN	30 45 65	7 16 33	G 1/2"	137	45	100	18
		-100 kN	10 kN							
		-200 kN	10 kN							
		-70 MPa	2 MPa							
		-10000 psi	500 psi							
AMP652	5	-400 kN	20 kN	90 110 140	64 95 154	G 1/2"	137	45	100	18
		-600 kN	50 kN							
		-1000 kN	50 kN							
		-70 MPa	2 MPa							
		-10000 psi	500 psi							
AMT650	2	-100 MPa	2 MPa			G 1/2"	137	45	100	18
		-14000 psi	500 psi							
AMT151	2	-160 MPa	5 MPa			M20x1,5	76,5	45	112	24
		-23000 psi	500 psi							
AMT301	2	-310 MPa	10 MPa			M20x1,5	76,5	45	112	24
		-45000 psi	1000 psi							
AMT801	2	-100 MPa	5 MPa			G 1/4"	50	28,5	60	15
		-15000 psi	1000 psi							
AMZ50	2	-800 kN	20 kN	100	79	G 1/2"	137	45	100	18
		-80 ton								
AMZ250	2	-24 ton	1 ton	65	33,1	G 1/2"	137	45	100	18
		-700 bar	20 bar							
TX102	3	-4 ton	1 ton	30 45	7 16	G 3/8"	130	45	100	18
		-10 ton	1 ton							
		-600 bar	50 bar							
TX104*	2	-160 MPa	5 MPa			G 1/4"	50	30	62	9
		-20000 psi	1000 psi							

AMT151
AMT301
AMT801
TX104

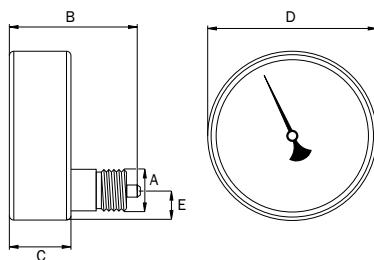

AMP651
AMP652
AMT650
AMZ50
AMZ150
AMZ250
TX102

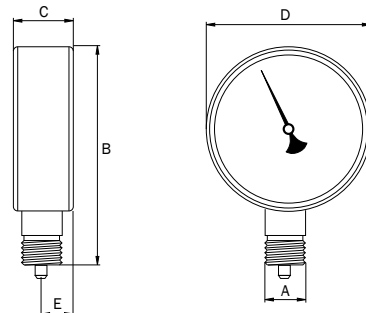

AAM / AVM / TX / ATM - GAUGE ADAPTOR

Whatever combination of pump and gauge you might have, we can offer the right adapter. Gauge adapters AAM201, AVM202 and TX111 have swiveling connection threads for gauge connection.

Note! All gauge adaptors are supplied with proper seals up on delivery except AAM14 which require an additional seal part number 17009.



Name	For perssure gauge	Ext. thread A	Int. thread B	Int. thread C	Max. pressure MPa/bar	
AAM14	AMT801, TX104	G 1/4"	-	G 1/4"	150/1500	
AAM201	AMP651, AMP652, AMT650, AMZ50, AMZ150, AMZ250	G 1/4"	-	G 1/2"	100/1000	
AVM202	AMP651, AMP652, AMT650, AMZ50, AMZ150, AMZ250	G 1/4"	G 1/4"	G 1/2"	100/1000	
AVM204	AMT801, TX104	G 1/4"	G 1/4"	G 1/4"	150/1500	
TX111	TX102	G 1/4"	G 1/4"	G 3/8"	80/800	
ATM214	AMT801, TX104	G 1/4"	G 1/4"	G 1/4"	100/1000	

ACCESSORIES FOR CF & CFC - SERIES

For CF / CFC cylinders (49 kN)

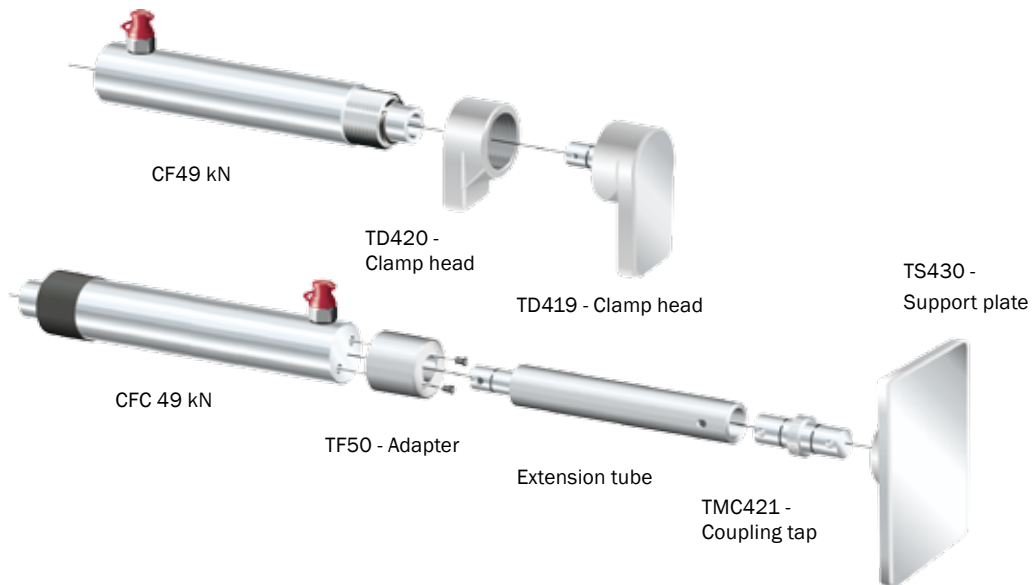

For CF / CFC cylinders (111 & 232 kN)

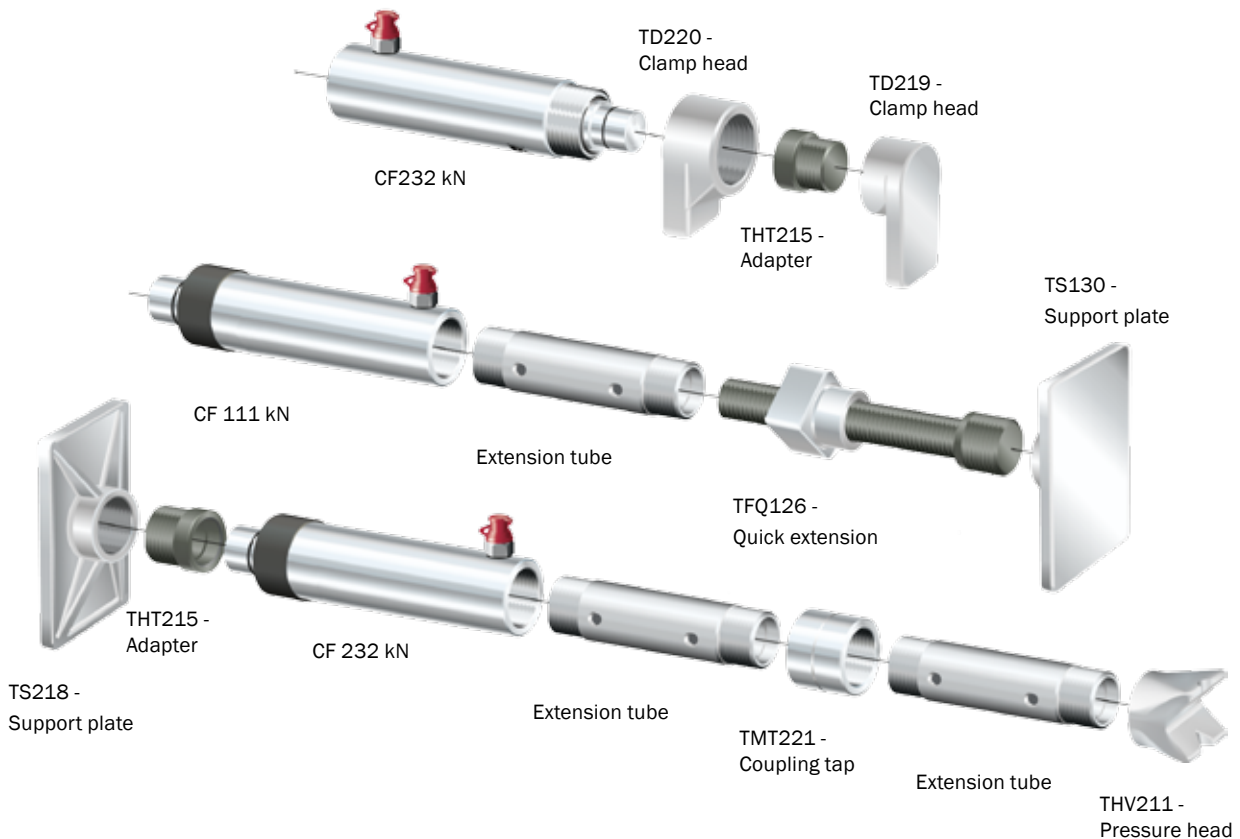

Cylinders within the CF and CFC series are general purpose cylinders. Both series includes a wide range of products with respect to various stroke lengths and product performance. The series are prepared to be equipped with several different accessories extending the use of the cylinders.

In order to connect accessories to the base plate of CFC cylinders, adapter TG50 (for 5 ton CFC cylinders), TFG100 (for 10 ton CFC cylinders) or TFG250 (for 25 ton CFC cylinders) are required.

TCF - CLEVIS EYE

For CFC - cylinders, used for adapting the cylinder base

- Making CFC-cylinders flexible and suitable for push & pull applications.
- Suitable for CFC cylinders 49 kN - 232 kN.

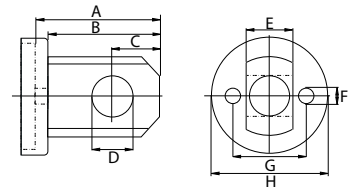

Name	For cylinder type	A	B	C	D	E	F	G	H	J
		mm	mm	mm	ø mm	mm	ø mm	mm	ø mm	ø mm
TCF50	49 kN/5 ton	48	41,5	16	16	14,2	7	25	44,5	29
TCF100	111 kN/10 ton	67	60,5	25,5	22,35	25,4	8,5	40	63,5	43
TCF150	166 kN/15 ton	67	60,5	25,5	22,35	25,4	10	48	77	43
TCF250	232 kN/25 ton	80	73,25	31,75	31,75	38,1	13,5	59	95	57

TKF - CLEVIS EYE

For CFC - cylinders used for adapting the cylinder piston

- Making CFC - cylinders flexible and suitable for push & pull applications.
- Suitable for CFC cylinders 49 kN - 232 kN.

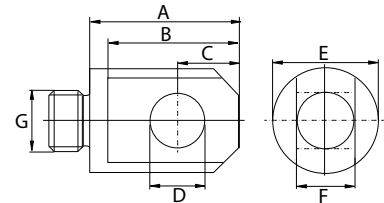

Name	For cylinder type	A	B	C	D	E	F	G
		mm	mm	mm	ø mm	ø mm	ø mm	
TKF50	49 kN/5 ton	41,5	34	16	16	29	14,2	3/4"-16 UNF
TKF100	111 kN/10 ton, 166 kN/15 ton	62	54	25,5	22,35	43	25,4	1"-8 UNC
TKF250	232 kN/25 ton	74,5	66,5	31,8	31,75	57	38,1	1 1/2"-16 UN

TF / TFG - ADAPTER

For CFC - cylinders, used for adapting the cylinder base

Name	For cylinder type	A	B	C
		mm	ø mm	
TF50	49 kN/5 ton	39	44,5	ø 19 mm
TFG50	49 kN/5 ton	39	44,5	3/4"-14 NPT
TFG100	111 kN/10 ton	45	65	1 1/4"-11 1/2 NPT
TFG250	232 kN/25 ton	50,5	98	2"-11 1/2 NPT

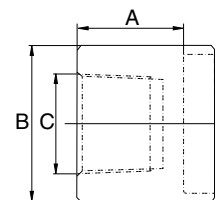

THT - ADAPTER

For CFC - cylinders, used for adapting the cylinder piston

Name	For cylinder type	A	B
THT50	49 kN/5 ton	3/4"-14 NPTF	3/4"-16 UNF
THT100*	111 kN/10 ton	1 1/4"-11 1/2 NPT	1"-8 UNC
THT250	232 kN/25 ton	2"-11 1/2 NPT	1 1/2"-16 UN

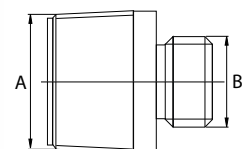

PRESSURE HEADS & EXTENSION TUBES

For CF & CFC cylinders

REHOBOT has a wide range of pressure heads for lifting, straightening or other operations.

Note! The maximal allowable extension varies per cylinder capacity. When using extension tubes there is a risk of cracking of the extension tubes. Extensions also reduces the capacity of the cylinder. See the graphic below for more information.



TH - PRESSURE HEADS

TFP - EXTENSION TUBES

Name	Description	Connction
For cylinders CF 49 kN/5 ton		
TH414	Pressure head, plain	Tap Ø 19 mm
THG413	Pressure ball ø 3"	Hole Ø 19 mm
THK412	Pressure head, pointed	Tap Ø 19 mm
THR415	Pressure head, grooved	Tap Ø 19 mm
THV411	Pressure head V-notched	Tap Ø 19 mm
For cylindrar CF & CFC ¹⁾ 111 kN/10 ton		
TH117	Pressure head, plain	Int. NPT 1 1/4-11 1/2
THG113	Pressure ball ø 3"	Int. NPT 1 1/4-11 1/2
THK112	Pressure head, pointed	Int. NPT 1 1/4-11 1/2
THR114	Pressure head, grooved	Int. NPT 1 1/4-11 1/2
THT115	Pressure head, ext. thread NPT 1 1/4-11 1/2	Hole Ø 32 mm
THV111	Pressure head V-notched	Int. NPT 1 1/4-11 1/2
THV118	Pressure head V-notched	Int. NPT 1 1/4-11 1/2
For cylinder CF & CFC ²⁾ 232 kN/25 ton		
THK212	Pressure head, pointed	Int. NPT 2-11 1/2
THR214	Pressure head, grooved	Int. NPT 2-11 1/2
THT215	Pressure head ext. thread NPT 2-11 1/2	Hole Ø 48 mm
THV211	Pressure head, V-notched	Int NPT 2-11 1/2

Name	Length mm	Hollow
For cylinder CF & CFC ¹⁾ 49 kN/5 ton		
TFP401	76	ø 19
TFP402	127	ø 19
TFP403	254	ø 19
TFP404	381	ø 19
TFP405	551	ø 19
For cylinder CF & CFC ²⁾ 111 kN/10 ton		
TFP101	76	NPT 1 1/4-11 1/2
TFP102	127	NPT 1 1/4-11 1/2
TFP103	254	NPT 1 1/4-11 1/2
TFP104	381	NPT 1 1/4-11 1/2
TFP105	585	NPT 1 1/4-11 1/2
TFP106	510	NPT 1 1/4-11 1/2
TFP107	760	NPT 1 1/4-11 1/2
For cylinder CF & CFC ³⁾ 232 kN/25 ton		
TFP203	254	NPT 2-11 1/2
TFP204	508	NPT 2-11 1/2
TFP205	762	NPT 2-11 1/2

1) - CFC-series require adapter TFG50
 2) - CFC-series require adapter TFG100
 3) - CFC-series require adapter TFG250

PERMISSIBLE EXTENSION FOR CF- & CFC - CYLINDERS

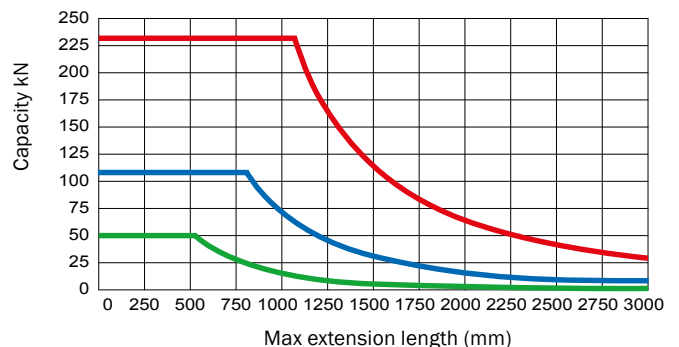

■ 232 kN CF/CFC ■ 111 kN CF/CFC ■ 49 kN CF/CFC

1) - CFC-series require adapter THT100
 2) - CFC-series require adapter THT150





OTHER ACCESSORIES

For CF & CFC cylinders

The accessories expand the usable range of the cylinder. Permitting the cylinder to be used for:











- Pushing applications
- Pulling applications







	Name	Connection
<i>For cylinders CF & CFC* 49 kN/5 ton</i>		
	TC428 Locking pin	-
	TD419 Clamp head for piston (max 20kN)	Tap ø 19 mm
	TD420 Clamp head for cylinder(max 20kN)	Int. UN 1 1/2-16
	TMC421 Coupling tap	Tap ø 19 mm
	TS430 Support plate	Hole ø 19 mm

* Accessories can be mounted on CFC - cylinder base by using adapter TF50

For cylinders CF & CFC 111 kN/10 ton*

	TC128 Locking pin	
	TD119 Clamp head for piston (max 50 kN)	Int. NPT 1 1/4-11 1/2
	TD120 Clamp head for cylinder(max 50 kN)	Int. UN 2 1/4-14
	TMC121 Coupling tap	Tap ø 32 mm
	TMT122 Coupling nipple	Ext. 2x NPT 1 1/4-11 1/2
	TMT124 Coupling nipple	Int. 2x NPT 1 1/4-11 1/2
	TK107 Chain with hook (2 m)	
	TOK109 Chain yoke	Int. UN 2 1/4-14
	TS130 Support plate	Int. NPT 1 1/4-11 1/2
	TSM131 Support plate with articulated tap	Ext. NPT 1 1/4-11 1/2
		

* Accessories can be mounted on CFC - cylinder base by using adapter TFG100

	Name	Connection
<i>For cylinders CF & CFC* 232 kN/25 ton</i>		
	TC228 Locking pin	-
	TMC221 Coupling tap	Tapp ø 48 mm
	TMT222 Coupling tap	Utv. 2x NPT 2-11 1/2
	TMT224 Coupling tap	Inv. 2x NPT 2-11 1/2
	TS218 Support plate	Inv. NPT 2-11 1/2

* Accessories can be mounted on CFC - cylinder base by using adapter TFG250



TCF - CYLINDER FIXING

For CF & CFC - cylinders

- Permitting a CF/CFC to be mounted on a machine part by screw holes.
- TCF52 is supplied without fastening holes and used for welding.
- Fits CF/CFC cylinders from 49 kN - 232 kN

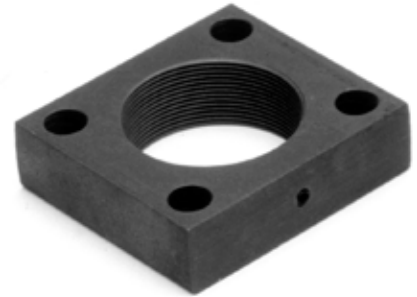

Name	TCF52	TCF4	TCF10	TCF20
For cylinders	49 kN/5 t	49 kN/5 t	111 kN/10 t	232 kN/25 t
A mm	∅ 59	70	90	140
B mm	-	60	80	120
C mm	25	25	25	25
D mm	-	54	67,5	106
E mm	-	41,2	57,5	86
F ∅ mm	-	11	13	17
G	-	M6	M6	M6
H	1 1/2" - 16UN	1 1/2"-16UN	2 1/4"-14UN	3 5/16"-12UN

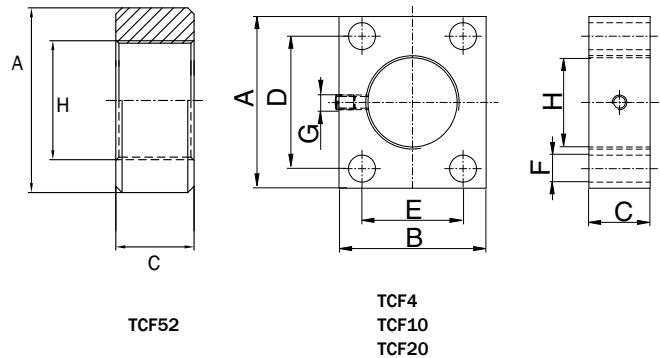

BENCH PRESSES

For CFC - cylinders

Bench presses are easy to place and only require a limited space. They are suitable for light work operations such as pressing bearings or bushings.

Complete bench presses are available in two versions. A (ZHB10) with REHOBOT air hydraulic pump PP70-1000 and the second version (ZMB6) utilized with REHOBOT hydraulic hand pump PHS70-1000.

Name	Capacity kN	Stroke mm	Weight kg
ZHB10	111	305	47.5
ZMB6	111	305	47.5

Included parts	ZHB10	ZMB6
Pump	PHS70-1000	PP70-1000 *)
Cylinder	CFC1012	CFC1012
Quick coupling	AQI7	AQI7
Hose	LS151ES	LS251ES
Gauge adaptor	AVM202	AVM202
Pressure gauge	AMP651	AMP651
Frame	ZB110	ZB110
V-block	TBV10 (2 st)	TBV10 (2 st)

*) Required air pressure 6-12 bar.

Name Accessories	Description
ZB110	Press stand
TBV10	V-block



ACCESSORIES FOR CHF & CHFA - SERIES TH - SADDLES

For CHF & CHFA - cylinders

Accessory saddles for hollow cylinders type CHF and CHFA, 6 to 100 tonnes.

For pressing or lifting applications it is recommended to use the grooved solid saddles (THR). We also offer two more types; with inner metric (THM) and UN (THU) threads. The saddles THH are supplied as standard on all CHFA cylinders.



Name	For cylinder	Inner dimension
THH6	CH/CHF62	ø17mm - standard
THM6	CH/CHF62	M16
THU6	CH/CHF62	5/8"-11 UNC
THR6	CH/CHF62	Solid with grooves
THH13	CHFA132/136	Ø22 mm - standard
THM13	CHFA132/136	M20
THU13	CHFA132/136	3/4"-10 UNC
THR13	CHFA132/136	Solid with grooves
THH18	CHFA182/184	Ø26 mm - standard
THM18	CHFA182/184	M24
THU18	CHFA182/184	1"-8 UNC
THR18	CHFA182/184	Solid with grooves
THH26	CHFA262/266	Ø32 mm - standard
THM26	CHFA262/266	M30

Name	For cylinder	Inner dimension
THU26	CHFA262/266	1 1/4"-7 UNC
THR26	CHFA262/266	Solid with grooves
THH37	CHFA372/374	Ø39 mm - standard
THM37	CHFA372/374	M36
THU37	CHFA372/374	1 3/8"-6 UNC
THR37	CHFA372/374	Solid with grooves
THH67	CHFA673/676	Ø54 - standard
THM67	CHFA673/676	M52
THU67	CHFA673/676	2"-4 UNC
THR67	CHFA673/676	Solid with grooves
THH100	CHFA1003/1006	Ø66 - standard
THM100	CHFA1003/1006	M64
THU100	CHFA1003/1006	2 1/2"-4 UNC
THR100	CHFA1003/1006	Solid with grooves

TS - CYLINDER SUPPORT PLATE

For CHFA - cylinders

Cylinder support plates suitable for CHFA single acting aluminium hollow cylinders are made of steel and are used for protecting the cylinder base against damages. TS cylinder support plates should always be used when the cylinder base is placed against hard material. A support plate is a simple and cost effective way to protect your cylinder.







Name	For cylinder kN	Weight kg
TS13	CHFA132/136	0,1
TS18	CHFA182/184	0,2
TS26	CHFA262/266	0,5

Name	For cylinder kN	Weight kg
TS37	CHFA372/376	0,7
TS67	CHFA673/676	1,5
TS100	CHFA1003/1006	2,8





ACCESSORIES FOR CPF - SERIES

For cylinder CPF705 (49 kN)

	Name	Description	Connection
	TB441	Pull shackle	Int. NPT 3/4-14
	TBK410	Shackle with bolt	-
	TMT422	Coupling nipple	Ext. 2x NPT 3/4-14
	TMT423	Coupling nipple	Int. NPT 3/4-14 Ext. NPT 1 1/4-11 1/2



For cylinder CPF709 (111 kN)

	Name	Description	Connections
	TB141	Pull shackle	Int. NPT 1 1/4-11 1/2
	TBK110	Shackle with bolt	-
	TK107	Chain with hook (2000 mm)	-
	TMK127	Chain attachment	Int. NPT 1 1/4-11 1/2
	TMT122	Coupling nipple	Ext. 2x NPT 1 1/4-11 1/2



HYDRAULIC SPREADER

ESH, CS & HS - SERIES

Hydraulic spreaders can be used to pry apart, press, widen or lift where space is limited or the opening is narrow. The tool can be used within many different areas such as mechanical workshops and building industry for maintenance and repair, civil and military rescue services etc.

- Lifting machines or other heavy constructions.
- Prying loose stuck objects.
- Open closed doors.
- Fasten objects.
- Press profiles apart.

We recommend usage of pump model PP70-1000/LS201 or hand pump PHS70-1000/LS201 together with spreaders in the ESH & CS - series.



CS20-120

HS20-120

Name	Part number	Spreader force kN (tip)	Working pressure MPa	Max. opening mm	Min height mm	Width mm	Weight kg
ESH 10	14507	9	70	85	8	46	1.8
CS20-120	38362900	44 (20)	80	120	9	65	5.4
HS20-120	38911900	44 (20)	Integrated pump	120	9	68	8.8

HYDRAULIC PULLERS

AH - HYDRAULIC 3-ARM PULLERS

REHOBOT hydraulic pullers are designed for tough industrial applications and are available in sizes from 5 ton to 44 ton. The rugged design will make this a work-horse for many years to come.

- Rugged industrial design.
- Safe and stable pull operations as piston is non rotating
- Self straining.

The benefits of a hydraulic puller, compared with a mechanical one, are many; key being non rotating piston / press head. This allows the user to carry out the pull safely without the risk of slipping.

The smaller sizes, 5 ton and 10 ton, are equipped with special mechanics which self centers the arms. The arms will therefore always adapt to the diameter of the object and have the best possible grip and handling. All REHOBOT pullers are furthermore self straining and have an extra long stroke. The pull depth can easily be adjusted by moving the arm attachments.

The pullers can be used with 2 or 3 arms (not the AH450 - only 3 arms). Different lengths of arm are available as accessories.

Choose a suitable pump kit - many REHOBOT pumps fit our pullers but we recommend either our PHS70-1000/LS201 kit or rather the air driven foot pump type PP70B-1000/LS201. Both types are equipped with a 2 m hose, a swivel and a REHOBOT AQI7 quick coupling.



Name	Part number	Working pressure MPa	Capacity kN (t)	Max. opening mm	Stroke volume cm ³	Weight kg
AH50	37143	70	49(5)	250	165	6.4
AH110	37151	70	111/11	400	485	15.1
AH200	37159	70	200(20)	500	1032	23.7
AH450	37163	70	450(46)	700	1272	76.1

AHV50-110 - PULLER BUGGY

Hydraulic pullers are heavy tools. Especially when you need the tool on a day-by-day basis. This is where the puller buggy comes in very handy. The hydraulic pullers and the accessories stay in one single place, easy accessible when you need them. The puller buggy is equipped with 4 swiveling wheels, two of them lockable.

The puller buggy is delivered as standard with the following items:

- TV50-110 - Buggy with winch
- AH50 - 5 T Puller
- AH110 - 10 T Puller
- EAT50-110 - Push mandrel kit
- PP70-1000/LS251ES - Pump with hose and couplings
- AMK802 - Gauge kit
- 110-390 - Puller arms
- 110-490 - Puller arms
- 20-20 - Safety chain



Two additional accessory kits are available:

- PK50 - Pin- knife puller kit 5 T (Part no. 37146)
- PK110 - Pin- knife puller kit 10 T (Part no. 37154)

Name	Part number	Working pressure MPa	Capacity kN	Length mm	Width mm	Height mm	Weight kg
AHV50-110	47949	70	49-110	800	800	1650	93



WORKSHOP EQUIPMENT – QUALITY FOR GENERATIONS!

REHOBOT's workshop equipment is user friendly and designed to cope with harsh in situ service conditions. The areas of use of the products are wide and may often be found in conjunction with service & maintenance on all kind of vehicles.

REHOBOT's lifting equipment is used worldwide and in all possible applications. Some examples are in the service of heavy and light vehicles, special lifts for trucks or for changing crawler on an excavator.

We are happy to tailor our products to our customers' needs. Something that always ensure a flexible and cost effective solution to our customers' lifting problems.

Our designs are based on our long experience in the field of hydraulics. The results are products which are easy to repair & service - saving time & money! The useable life of REHOBOT's products is always long. Our products provide power that will last for generations!

Trolley jacks - The product range includes traditional jacks with lifting capacities up to 2 tons. They are robustly constructed and easy to service. Our trolley jacks are

often used in connection with engineering works and REHOBOT's jacks are associated with a high level of safety.

Bottle jacks - With up to 20 tonnes lifting capacity can the bottle jacks in REHOBOT's range be used in automotive or related applications. The jacks are compact designed and suitable for storage in confined spaces.

Special Lifting - The product range includes devices for specific lifting applications. High stroke lengths, heavy loads or low and limited lifting points are some special cases that REHOBOT's lifting devices can be adapted to. The catalog shows some of the variants that evolved during our 80-year long history of the company.

Please contact us for further information or to discuss developing a special jack for your application.

REHOBOT'S PRODUCTS ARE

- High performance
- High quality & Service friendly
- Functional & Safe designed
- Ergonomical & Easy to use

SPECIAL EQUIPMENTS

- Transmission jacks for gears or engines
- Hydraulic ball joint extractors & spring compressors
- Special push & pull kits for bushing works

GTP - AIR/HYDRAULIC TELESCOPIC JACK

- 3-stage jack with 60 tons lifting capacity.
- Easy to manoeuvre with large rubber wheels.
- 617 mm maximal lifting height by a telescopic piston function.
- Extended handle length for good accessibility.

Capacity limitations: 1 - stage = 60 ton, 2 - stage = 30 ton, 3 - stage = 18 ton

A 200mm long extension rod are delivered with each GTP60 - unit. The rod is used to extend the lifting height of the GTP-60 product.

Note: GTP60 requires between 8 bar and 12 bar air pressure to function properly.



Name	Part number	Capacity ton	Min. height mm	Max. height mm	Extension mm	Hydraulic stroke mm	Req. air pressure MPa (bar)	Weight kg
GTP60	43450	60	180	617	200	237	0.8 (8)	70

16HN - HIGH PROFILE JACK

- Various usage for lifting, pressing or pushing applications.
- 1 ton lift capacity on the lifting ram and on top of the oil reservoir.
- 16HN can be equipped with accessories such as chains, hooks or S-rods.

The position of the lifting rod can be adjusted:
Min. lifting height = 105 mm, Max. lifting height = 495 mm (plus stroke length)

Name	Part number	Capacity ton	Min. height mm	Max. height mm	Stroke length mm	Weight kg
16HN	49085	1	720	1160	440	5.8



GHP2-2 - AIR POWERED HIGH LIFTING TROLLEY JACK

- High-lifting, enable good accessibility
- Protector, for safe and secure lifting.
- Air- or manually operated.

REHOBOT's trolley jacks are developed for professional use by professionals. Especially for users who value product quality and a low total cost of ownership of the jack. The GHP2-2 jack can quickly be put into operation as it comes with a manual foot lever to raise the jack into contact with the vehicle.

The release function is easily done by the release valve securely located inside the handle.



Name	Part number	Capacity ton	Min. height mm	Max. height mm	Length mm	Weight kg
GHP2-2	37589	2	127	910	1510	74

BOTTLE JACKS

H - BOTTLE JACKS

- Low manual pumping force facilitates use in uncomfortable positions.
- Release valve permits safe, easy and precise control over speed of lowering.
- Filter in the oil reservoir protects against contamination.
- Extension screw for adjustment of lifting height.



Name	Part number	Capacity ton	Min. height mm	Max. height mm	Stroke length mm	Set screw mm	Weight kg
H20	43503	2	165	317	102	50	2.8
H40	43504	4	180	366	116	70	4
H60	43505	6	195	392	127	70	5
H80	43506	8	200	400	130	70	6.2
H100	43507	10	220	430	140	70	7.3
H120	43508	12	220	440	140	80	8.5
H150	43509	15	225	435	130	80	9.6
H200	43510	20	240	465	145	80	13.6

AXLE STANDS

PB - MECHANICAL AXLE STANDS

- Step-less adjustment of lifting height.
- Tripoid designed structure guarantee stability & safety.
- Always delivered in pairs.

PB axle stands are rugged & stable axle stands in a new design creating a safe working environment. Using axel stands is very cost effective way to protect yourself & the lifted object. Securing the load by the use of axel stands are always recommend when working under any type of vehicle.

PB axle stands from REHOBOT comply with the high requirements of the National Swedish Board of Occupational Safety and Health.



Name	Part number	Capacity ton	Min. height mm	Max. height mm	Weight kg
PB3-1	46346	3	324	519	5.9
PB6-1	46347	6	374	605	8.8

SPECIAL JACKS

FLJ400 - HYDRAULIC TRUCK- & MACHINE JACK

- High lifting capacity and low minimum height.
- Adjustable lifting saddle for flat or uneven surfaces.
- Low weight, easy to transport.
- Release knob with hold-to-run control.



Name	Part number	Capacity ton	Min. height mm	Max. height mm	Width mm	Weight kg
FLJ400C	47059	3.6	60	400	200	31

MM2000 - HYDRAULIC TRANSMISSION JACK

- Jig for securing load quickly and easily. Can easily be removed if required.
- Fast & versatile lifting plate can be adjusted forwards/backwards and sideways for precise positioning during fitting and removal.
- Capable of handling most types of gearboxes.



Name	Part number	Capacity ton	Min. height mm	Max. height mm	Length mm	Width mm	Weight kg
MM2000	37601	1	210	880	1120	710	95



HTJ1200 - UNIVERSAL LIFTING SYSTEM

The modular construction methods now used in the automotive industry are placing new demands on workshop equipment. Vehicle parts such as motor blocks or rear axles have to be dismantled and mounted from below. With the HTJ1200 system, these heavy lifts can be done in a effective and controlled way.

The system is suitable for removing and fitting complete engine assemblies, rear axles, gearboxes, fuel tanks, exhaust systems and much more. With its lifting capacity of almost 550 kg, the HTJ1200 universal handling system comes with enough power for all kinds of jobs



- Saving time & cost

Work can be carried out by one person instead of several. Furthermore, additional repair jobs can be carried out directly on the working platform. Therefore, the system reduces the total working time for complete repairs.

Lifting is done pneumatically and hydraulically. With pneumatics the load can be raised or lowered quickly. The hydraulic lifting gives the operator higher control and precision of the lifting procedure.

REHOBOT's universal handling system is patented. The system is designed to meet today's and tomorrow's needs. Modification meeting the requirements of your car model may be supplied upon request.



Technical data

Name	HTJ1200-2 Universal
Part number	43447
Capacity	545 kg
Height min./max.	755 mm/1700 mm
Pneumatic stroke	472 mm
Hydraulic stroke	473 mm
Req. air pressure	0.8 MPa (8 bar)
Length	1050 mm
Width	1050 mm
Weight	76 kg

Please contact REHOBOT to obtain item number in conjunction with your order of the HTJ-1200 system. We offer a wide selection of interface mechanics and kits adopting the HTJ to your type of vehicle model.



SECRETS OF THE HTJ - SYSTEM

The reason why the HTJ1200-system is so useful is due to the modular & robust design of the system.

Adaptors enable the same base unit of the HTJ to be used for each car model. Therefore the same base unit may be used independent of the car model and manufacturer. Thus creating a real generic lifting system!

AUTOMOTIVE KITS

EBH - SPRING EYE BUSH REPLACEMENT KIT

- Safe, simple and speedy hands free process.
- Up to 50-60% time & labour cost saving.
- The lightweight & compact design allows work to be carried out on the vehicle where access is restricted.
- Little or no manual effort required.
- All work can be carried out in situ on the vehicle.
- At a total weight of 8 kg fully assembled falls well within EU manual handling of loads regulations.
- Can be easily and cheaply upgraded should new vehicles be introduced on to the market at a future date.



Name	Part no	Pressure MPa	Capacity kN (t)	Cylinder	Pull rod	Adapter	Sleeve	Push Washer	Weight kg
EBH6	44592	70	62 (6)	CHF62	M12 x 500 M16 x 500	AD6-18	TA49 TA73	BR35/25-16 BR45/35-24 BR65/45-30	8.6
EBH13	44594	70	132 (13)	CHFA132	M16 x 500	AD6-18	TA49 TA73	BR45/35-24 BR65/45-30	11
EBH18	44598	70	182 (18)	CHFA182	M24 x 500	AD6-18	TA49 TA73	BR45/35-24 BR65/45-30	13
EBH18 Extended	49220	70	182 (18)	CHFA182	M16 x 500 M20 x 500 M24 x 500	AD6-18	TA49 TA73	BR35-16 BR45-16 BR55-20 BR65-20 BR72-24 BR90/80-45	13
EBH26	46957	70	262 (26)	CHFA262	M30 x 500	AD26-37	TA73 TA95	BR65/45-30 BR90/65-36	15.1
EBH37	46959	70	372 (37)	CHFA372	M36 x 500	AD26-37	TA73 TA95	BR90/65-36 BR110/90-36	22.5

Adapter: Used to support the sleeve against the cylinder. **Sleeve:** Used to "extend" the stroke length of the cylinder. TAxx, where xx is the inner diameter in mm.
Push washer: Used to push/pull the bushing. BRxx/XX-yy, where xx is outer diameter, XX is the diameter of the edge & yy is the inner diameter measured in mm.



Removing the old bush and inserting a new on a DAF CF85 truck by the use of a EBH18 - kit simply the work. The operation can be performed in a safe and rapid manner.

REHOBOT's EBH18 hydraulic spring eye bush replacement tools have been developed in conjunction with commercial vehicle manufacturers and vehicle workshop personnel to provide a lightweight, in situ time & labour saving solution for all makes & models of commercial vehicles.

Using REHOBOT's 18 ton capacity lightweight aluminium hollow bore cylinder and the comprehensive set of accessories contained within the kits the equipment can be easily used on any vehicle.

Sequence of operation using the EBH - kit

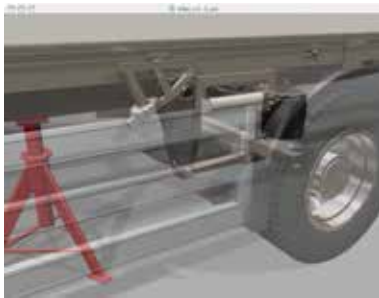

Step 1

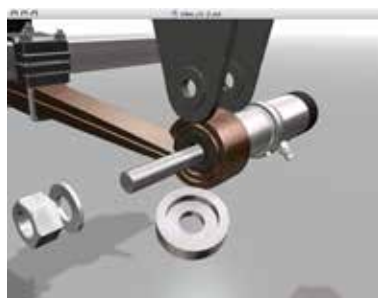

Step 2

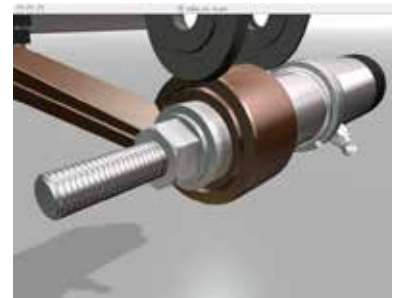

Step 3

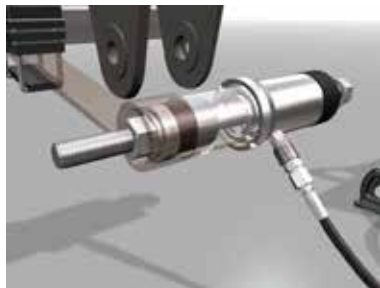

Step 4

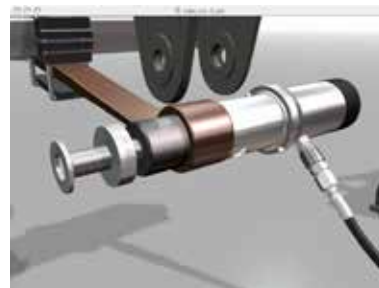

Step 5

PUMP ALTERNATIVES TO OPERATE ALL AUTOMOTIVE TOOLS & KITS

Each AUTOMOTIVE kit requires a suitable hydraulic pump unit. This is mandatory for all other hydraulic tools from REHOBOT. The kits may preferably be operated by either the PP70B-1000 pneumatic operated foot pump or the PHS70-1000 hydraulic hand pump.



More comfort – PP70B-1000



More portable – PHS70-1000

ETC37 & ETC50 PIN & BUSH REPLACEMENT TOOL KITS

REHOBOT'S ETC37 and ETC50 hydraulic pin & bush extraction tool kits have been developed in conjunction with the major manufacturers of heavy plant and special purpose machines for the construction industry to provide a lightweight, in situ, time and labour saving solution for the demanding service requirements on these machines.

- Safe, simple, hands free operation
- Up to 60% time and labour saving
- Can be adapted to suit all makes of construction plant and heavy equipment
- Flexible and adaptable system
- Improved health and safety over traditional methods
- Breakout & extension sleeves common to 37 & 50 ton kits
- Can be used across most pin & bush applications in use in the industry
- All work carried out in situ on the vehicle
- Suitable for on site and workshop repairs



Using REHOBOT'S 37 and 50 ton lightweight aluminium hollow bore 37 ton and 50 ton cylinders together with the unique stacking sleeve system and comprehensive sets of accessories incorporated in these tool kits the equipment can be easily used on any make of machine.

Name	Part number	Pressure MPa	Capacity kN (t)	Stroke mm	Cylinder type	Weight kg
ETC37	48072	70	358 (36)	51	CHFA372	24.3
ETC50	48073	70	508 (52)	104	CHFA504	46.6



INCLUDED PARTS IN THE ETC - KITS

Name	ETC37	ETC50	Description	Data
CHFA372	Yes	-	Cylinder	37 ton
CHFA504	-	Yes	Cylinder	52 ton
TR36-1000	Yes	-	Pull rod	M36 x 1000 mm
TR48-1000	-	Yes	Pull rod	M48 x 1000 mm
TAS95	Yes	Yes	Sleeve	ø95 mm
TC115	Yes x 2	Yes x 2	C-sleeve	ø115 mm, l = 135 mm
TC175	-	Yes x 2	C-sleeve	ø175 mm, l = 135 mm
TP115	Yes	Yes	Adapter	För TC115
TP175	-	Yes	Adapter	För TC175
TAD24-36	Yes	-	Thread adpt.	M24 (ext) -> M36 (int)
TAD30-36	Yes	-	Thread adpt.	M30 (ext) -> M36 (int)
TAD30-48	-	Yes	Thread adpt.	M30 (ext) -> M48 (int)

The 50 ton kit in use on a Volvo L150.

BEU110 – THE IN SITU BALL JOINT EXTRACTOR KIT

REHOBOT's unique BEU110 10 ton multi headed ball joint extractor is a superb complimentary tool to the spring eye bushing kits. This tool has again been developed in conjunction with leading commercial vehicle manufacturers and workshop personnel to ensure that it covers virtually all the ball joints currently in use on vehicles on the present market.

The BEU110's compact size and design allows it to access the majority of ball joints on vehicles such as: DAF, MAN, Mercedes, Scania, Volvo, Iveco & Hino.

Also, the 10 ton load capacity ensures quick separation of the joint.

Accessories

TD40	40 mm "horse shoe"
TD50	50 mm "horse shoe"
TD75	75 mm "horse shoe"
BE110 & adapter kit ADK	Dedicated add on kit for Mercedes Benz Sprinter



Name	Part number	Pressure MPa	Capacity kN (t)	Stroke mm	Stroke volume cm ³	Weight kg
BEU110	47570	70	110(11)	54	86	3.8

SECRETS OF THE BEU - SYSTEM

- Interchangeable horse shoe heads 40 & 50mm included.
- Safe hands free operation.
- Full 10 ton breakout force.
- Covers most ball joints currently on the market.
- Adapters available to allow in situ replacement of ball joints.
- Cost effective & labour saving.
- Future proof due to modular design.



BEU110 c/w 50mm horseshoe on a Scania Truck

PUSH & PULL KITS

EB/ES/EU - HYDRAULIC PUSH & PULL KITS

- A multi functional robust tool box for all maintenance jobs.
- 5, 11 or 23 ton capacity.
- Flexible tool kit for push or pull applications.
- Interconnects with many other REHOBOT accessories.
- Strong storage case.



Note: Content may differ dependent on kit-type.

Name	Part number	Pressure MPa	Capacity kN (t)	Weight kg
EB50	49508	70	49 (5)	14
ES50	49509	70	49 (5)	18
EU50	49510	70	49 (5)	25
EB110	49511	70	111 (11)	21
ES110	49512	70	111 (11)	27
EU110	49513	70	111 (11)	42
ES230	49514	70	232 (23)	44

Depending on what the push-pull kit is used for, you can choose between three different kits: basic, standard and universal. Each kit contains several different accessories for the ram, which makes the kit ready to be used in different applications and for various purposes. All kits come with a push ram. If the job is carried out on different locations, we recommend a hydraulic hand pump in the PHS-series. An air/hydraulic pump PP70-series is the better choice when you have access to compressed air. This pump is also more comfortable and faster to work with.

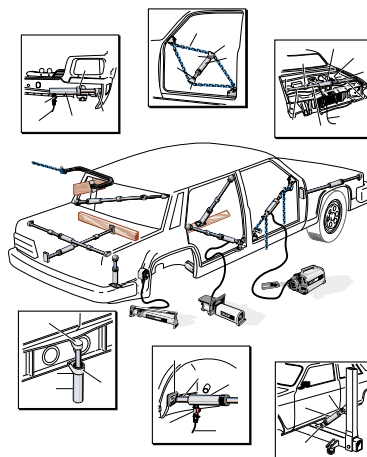

Basic kit (EB-kit)

The basic kit contains a push ram with various capacity dependent on the size of the kit. Furthermore the kit comes with and several accessories such as extension tubes and pressure heads.

Standard kit (ES-kit)

















The standard kit contains the same pieces as the basic kit. Additionally it comes with a spreader and more accessories for the ram. The accessories make the ram more flexible.

Universal kit (EU-kit)

The universal kits contain all the parts from the standard and basic kits. Furthermore, it comes with a pull ram, a pull chain and some accessories for the pull ram.

Please refer to the chart on the next page for information about the contents of the kits.

Ex50 (5 ton KIT) - TABLE OF CONTENTS

	Name	Description	EB50 kit	ES50 kit	EU50 kit
	CF104	Push cylinder 49 kN, 127 mm stroke	●	●	●
	TD419	Clamp head for piston, 20 kN, tap ø19 mm	●	●	●
	TD420	Clamp head for cylinder, 20 kN, UN 1 1/2-16	●	●	●
	TFP401	Extension tube, l = 76 mm			●
	TFP402	Extension tube, l = 127 mm	●	●	●
	TFP403	Extension tube, l = 254 mm	●	●	●
	TFP404	Extension tube, l = 381 mm	●	●	●
	THK412	Pressure head, pointed, tap ø19 mm	●	●	●
	THV411	Pressure head, V-notched, tap ø19 mm	●	●	●
	TL125	Metal case 677x300x165 mm	●	●	●
	ESH10	Spreader, 9 kN, max opening 90 mm		●	●
	THG413	Pressure head, rubber ball 3", tap ø19 mm		●	●
	TMC421	Coupling tap, ø19 mm		●	●
	TS430	Base plate, hole ø19 mm		●	●
	CPF705	Pull cylinder, 40 kN, 125 mm stroke			●
	TB441	Pull schakle for CPF705			●
	TK107	Chain with hook, L = 2000 mm			●
	TMK127	Chain attachment for CPF705 & 709			●
	TMT423	Int. NPT 3/4-14, Ext. NPT 1 1/4-11 1/2			●
	TMT422	Coupling nipple, 2 x NPT 3/4-14			●



PUMP ALTERNATIVES TO OPERATE PUSH & PULL KITS

Each PUSH & PULL kit requires a suitable hydraulic pump unit. This is mandatory for all hydraulic tools from REHOBOT. The kits may preferably be operated by either the PP70B-1000 pneumatic operated foot pump or the PHS70-1000 hydraulic hand pump.



















More comfort –
PP70B-1000/LS201



More portable – PHS70-1000









PUSH & PULL KITS

Ex110 (11 ton KIT) - TABLE OF CONTENTS

	Name	Description	EB110 kit	ES110 kit	EU110 kit
	CF110	Push cylinder 111 kN, 150 mm stroke	•	•	•
	TD119	Clamp head for piston, 50 kN, NPT 1 1/4 - 11 1/2	•	•	•
	TD120	Clamp head for cylinder, 50 kN, UN 2 1/4 - 14	•	•	•
	TFP101	Extension tube, l = 76 mm			•
	TFP102	Extension tube, l = 127 mm	•	•	•
	TFP103	Extension tube, l = 254 mm	•	•	•
	TFP104	Extension tube, l = 381 mm	•	•	•
	THK112	Pressure head, pointed, NPT1 1/4 - 11 1/2	•	•	•
	THT115	Pressure head, threaded NPT 1 1/4 - 11 1/2	•	•	•
	THV111	Pressure head, V-notched, NPT 1 1/4 - 11 1/2	•	•	•
	TMT124	Coupling nipple, int. thread NPT1 1/4 - 11 1/2	•	• (x2)	• (x2)
	TL125	Metal case 677x300x165 mm	•	•	•
	ESH10	Spreader, 9 kN, max opening 85 mm		•	•
	THG113	Pressure head, rubber ball 3", NPT 1 1/4 - 11 1/2		•	•
	TMC121	Coupling tap, ø32 mm		•	•
	TMT122	Coupling nipple, 2 x NPT 1 1/4 - 11 1/2		•	•
	TS130	Base plate, NPT 1 1/4 - 11 1/2		•	•
	CPF709	Pull cylinder, 110 kN, 127 mm stroke			•
	TB141	Pull schakle for CPF709			•
	TK107	Chain with hook, L = 2000 mm			•
	TMK127	Chain attachment for CPF709			•



ES230 KIT - TABLE OF CONTENTS

	Name	Description	ES230 kit
	CF120	Push cylinder 232 kN, 127 mm stroke	●
	TFP203	Extension tube, l = 254 mm	●
	TFP204	Extension tube, l = 508 mm	●
	TFP205	Extension tube, l = 762 mm	●
	THK212	Pressure head, pointed, NPT 2 - 11 1/2	●
	THT215	Pressure head, threaded NPT 2 - 11 1/2	●
	THV211	Pressure head, V-notched, NPT 2 - 11 1/2	●
	TL225	Metal case 772x285x180 mm	●
	TMT224	Coupling nipple, int. thread NPT 2 - 11 1/2	●
	TMT222	Coupling nipple, 2 x NPT 2 - 11 1/2	●
	TS218	Base plate, NPT 2 - 11 1/2	●



PUMP ALTERNATIVES TO OPERATE PUSH & PULL KITS

Each PUSH & PULL kit requires a suitable hydraulic pump unit. This is mandatory for all other hydraulic tools from REHOBOT. The kits may preferably be operated by either the PP70B-1000 pneumatic operated foot pump or the PHS70-1000 hydraulic hand pump.



More comfort –
PP70B-1000/LS201



More portable – PHS70-1000

PERMISSIBLE EXTENSION FOR CF- & CFC - CYLINDERS

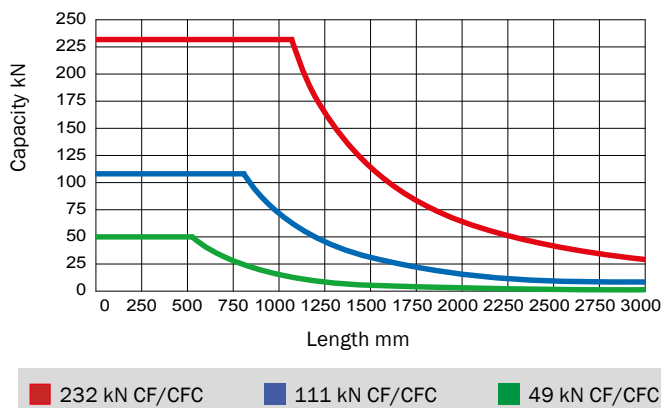

KPP23 – 23 TON HYDRAULIC KING PIN PRESS

One notoriously tricky task carried out by workshop staff is the removal of a seized king pin – a vital steering system component connected to the stub axle.

User friendly - Traditional solutions to the problem are far from ideal. One method employs an acetylene torch to heat up the axle, expanding it slightly so that the king pin can be forced out with a heavy, blunt instrument such as a sledge hammer. REHOBOT's 23 ton King Pin Press is a far more simpler, hydraulic solution to the problem.

Robust design - With a spread of 165mm and reach of 457mm, and its 23 ton capacity allows it to remove around 80% of all commercial vehicle king pins & stub axles on the market. It comes complete with a set of 4 pusher pin in various diameters and lengths.



More comfort – PP70-1000



More portable – PHS70-1000

Name	Part number	Pressure MPa	Capacity kN (t)	Frame width mm	Frame length mm	Pusher pin diameter mm	Weight kg
KPP20	50218	70	230 (23)	165	457	18, 20, 25, 35	39



Assemble the KPP20, push the hydraulic pump – the pin pops out. Job done!



Replacing a seized king pin can be a time consuming process. Using the KPP20 means keeping trouble and labour time for this kind of job to a minimum.

SC23 – SPRING COMPRESSOR

The hydraulic spring compressor from REHOBOT is a universal and very powerful tool. The spring compressor uses exchangeable jaws (ordered as accessories) in order to suit any car model.

Universal - The hydraulic spring compressor uses common jaws which in many cases are already part of the workshop equipment. Jaws are available for many different car models.

Safe - Mechanical tools with worn-out and heavy loaded parts mean a higher risk for personal injury. The hydraulic spring compressor has minimal wear and is therefore much safer than comparable mechanical tools.

Easy to operate - The hydraulic spring compressor is equipped with a quick-coupling which makes it easy to connect the tool to a foot-operated air/hydraulic pump. Thanks to the pump, the operator has both hands free for controlling the tool. Further more, the spring compressor is provided with a flexible holding block, which allows the tool to be placed in a suitable angle on a work bench.



Accessory jaws

Name (Pair)	Spring size ø (mm)
KL-1500SP	70 - 100
KL-1510SP	80 - 165
KL-1520SP	155 - 195

Name	Part number	Pressure MPa	Max. load kN (t)	Min. length mm	Max. length mm	Compression length mm	Weight kg
SC23	45195	70	23 (2.3)	73	483	250	7.8

SPECIAL JACKS HYDRAMITE & HYDRACLAW



Hydraclaw has the following features:

- Powerful - 5 tonne capacity on head or toe
- High lift - 178mm
- Fast Operation - 5.5mm lift per stroke
- Stable - substantial base offers stability under load
- Versatile - horizontal or vertical operation
- Safe - positive stop feature prevents over-stroking, pressure relief valve prevents overloading
- Ease of Operation - lifting/lowering controlled smoothly by operating lever, acceptable lever effort
- Low Clearance - 41mm
- Reliable - jack hydraulics are totally enclosed
- Robust Construction - can withstand rough treatment, ferrous construction has led to its extensive use underground

Hydramite has the following features:

- Powerful – 6.5, 10 and 15 tonne capacity
- Servicing and repairs easily undertaken
- Versatile – operates in any orientation
- Easy to Operate
- Proven – thousands in use worldwide
- Safe - relief valve prevents overloading
- Construction – all parts enclosed, ideal for dusty conditions
- Compact and Lightweight

Name	Part number	Capacity ton	Min. height mm	Max. height mm	Stroke length mm	Weight kg
Hydraclaw	33702	5	41	505	178	17
Hydramite	44077	6.5	132	208	76	3.6

REHOBOT®

MADE IN SWEDEN

POWER WITH HYDRAULICS

RESCUE EQUIPMENT

PRODUCT OVERVIEW



SAFETY

CUTTERS, SPREADERS, RESCUE PUMPS,
PIPE SEALING TOOLS, DOOR OPENERS,
RESCUE KITS, MANUAL TOOLS, RAMS



REHOBOT HYDRAULICS AB

Since 1924 we have developed, manufactured and marketed high-pressure hydraulic solutions for service & maintenance purposes. The products can be found within the areas covered by our three business areas, Industrial, Automotive and Rescue.

Our headquarter is situated in Eskilstuna, Sweden. Today REHOBOT deliver high-pressure hydraulics worldwide. Success for us involve exceeding limitations and to develop smart solutions for our customers' power problems.

REHOBOT HYDRAULICS stands for Quality, Reliability & Service. Our products are marketed by ourselves but also through dealers. We have subsidiaries in the U.S., England and China. In addition to these, we work with partners in more than 70 countries which always ensure that our customers receive the best possible service, wherever they are!

"HYDRAULICS WITH BUILT-IN NATURAL FORCES USED IN A VAST NUMBER OF APPLICATIONS"

REHOBOT®

MADE IN SWEDEN

REHOBOT HYDRAULICS AB

P.O. Box 1107
SE-631 80 Eskilstuna, SWEDEN
T: + 46 (0)16 16 82 00
F: + 46 (0)16 13 93 16
info@rehobot.se

REHOBOT INC (USA)

3980 W. Albany, Unit #1
MCHENRY, IL 60050, USA
T: +1 815 385 7777
F: +1 815 385 7776
info@rehobot.us

REHOBOT LTD (UK)

Unit 6, Stechford Trading Estate
Lyndon Road, Stechford
BIRMINGHAM B33 8BU, UK
T: + 44 121 789 77 07
F: + 44 121 789 68 66
info@rehobot.co.uk

www.rehobot.eu

Visit our website

Keep updated by visiting REHOBOT on the Internet. On our site you find the latest information about our products, contact information to your local REHOBOT - dealer, dates for future exhibitions, catalogues for download & much more.

www.rehobot.eu